



USER MANUAL

COMPUTRAC® MAX® 4000/4000XL MOISTURE ANALYZER

Firmware Revision 2.0X
October 2024

AMETEK BROOKFIELD

3375 N Delaware Street | Chandler, AZ 85225 USA
800.528.7411 | 602.470.1414 | f 602.281.1745

www.brookfieldengineering.com

Email:

Sales – sales.computrac@ametek.com
International – international.computrac@ametek.com
Customer Service – customerservice.computrac@ametek.com

Computrac® MAX® 4000 / 4000XL

PROPRIETARY RIGHTS NOTICE

This manual contains valuable information developed by AMETEK Brookfield for use with the Computrac® line of moisture analyzers. No part of this manual can be reproduced or transmitted in any form or by any means, electronic, mechanical, or otherwise. This includes photocopying and recording or in connection with any information storage or retrieval system without the express written permission of AMETEK Brookfield.

ALL RIGHTS RESERVED



© Copyright 2008-2021 AMETEK Brookfield

PLEASE NOTE: There are 2 different instrument models in the MAX® 4000 series: the MAX® 4000 and the MAX® 4000XL, and features vary between the two models. Throughout this manual, MAX® 4000 is used to refer to both the MAX® 4000 and the MAX® 4000XL when describing common features or functionality. When there are specific differences between the two models, these are indicated through the usage of MAX® 4000XL for features that are only available in the MAX® 4000XL. Refer to the chart on page 13 for details regarding the feature differences between the models.

1. HOW TO USE THIS MANUAL

AMETEK Brookfield's Computrac® MAX® 4000 series moisture analyzers are advanced, highly customizable instruments. As a result, the manual for the MAX® 4000 is extensive, comprehensive and detailed. For best results, read this manual in its entirety and keep the manual available for reference during instrument operation. The manual is organized in sections to facilitate easily locating the information needed. The sections and their descriptions are as follows:

§2 TABLE OF CONTENTS starting on page **4**

§3 WARNINGS AND SAFETY INFORMATION starting on page **6**

To protect safety, health and property, this very important information should be read by anyone utilizing the MAX® 4000.

§4 PACKING and SHIPPING INSTRUCTIONS starting on page **9**

Refer to this section when unpacking the instrument and prior to shipping the instrument.

§5 INTRODUCTION starting on page **11**

An overview of the features of the MAX® 4000, a chart of the two different instrument models, a list of items included with the instrument, and a list of the optional accessories available.

§6 INSTRUMENT SETUP starting on page **15**

All of the setup instructions for the instrument, including selecting a location for the instrument, connecting a printer, computer or other accessory, utilizing the instrument keypad, and setting the display contrast are explained here.

§7 MOISTURE ANALYSIS TESTING starting on page **33**

This section provides a general overview of moisture analysis testing, details the steps involved in running a moisture analysis test on the MAX® 4000 and provides suggestions for dealing with specific sample types, such as liquids.

§8 MAIN MENU starting on page **39**

The options available from each menu in the MAX® 4000 are described here.

§9 WEB SERVER starting on page **86**

The usage of the optional Web Server package that allows the MAX® 4000XL to be accessed over a Local Area Network (LAN) or company intranet.

§10 PERFORMANCE VERIFICATION starting on page **92**

The MAX® 4000 contains several pre-programmed tests that can be run to verify continuing instrument function and performance, as detailed in this section.

§11 ROUTINE MAINTENANCE starting on page **94**

Maintenance and cleaning procedures necessary to maintain instrument performance and extend the life of the MAX® 4000.

§12 INSTRUMENT PROBLEMS starting on page **97**

A troubleshooting section to aid in resolving instrument related issues.

§13 TEST RESULT PROBLEMS starting on page **99**

A troubleshooting section to aid in resolving issues with Test Results.

§15 MAX® 4000 SPECIFICATIONS starting on page **102**

The technical specifications of the MAX® 4000 / MAX® 4000XL.

§16 WARRANTY page **104** - This section details AMETEK Brookfield's warranty policy.

All section numbers, titles and page numbers in **BOLD** in this manual are hyperlinks and can be clicked to simplify navigation within the PDF version of the manual. The **BACK** button found in most PDF software programs is also very helpful when navigating using the hyperlinks.

2. TABLE OF CONTENTS

1. HOW TO USE THIS MANUAL	3
2. TABLE OF CONTENTS	4
3. WARNINGS AND SAFETY INFORMATION	6
4. PACKING AND SHIPPING INSTRUCTIONS	9
5. INTRODUCTION	11
5.1. Hardware	12
5.2. Instrument Models	13
5.3. Oven	13
5.4. Inventory & Accessories	14
6. INSTRUMENT SETUP	15
6.1. Instrument Location	15
6.2. Interior of Test Chamber & Pan Support	16
6.3. AC Power Connection	16
6.4. User Interface Operation	18
6.5. Contrast Adjustment	19
6.6. Back Panel Connections	20
6.7. Connecting a USB Printer	21
6.8. Connecting a USB Drive	22
6.9. Connecting a Computer	22
6.9.1 USB Driver Setup	23
6.10. Connecting a USB Keyboard	27
6.11. Nitrogen Purge Use	28
6.12. Nitrogen Control Module	29
6.13. Bar Code Reader	31
6.14. Installing & Removing the External Filter	32
7. MOISTURE ANALYSIS TESTING	33
7.1. Performing a Test	35
7.2. Preparing Granular and Powdery Samples	38
7.3. Preparing and Testing Liquid Samples	38
8. MAIN MENU	39
8.1. Test Programs	40
8.1.1 Sample Name	42
8.1.2 Temperatures	43
8.1.3 Ending Criteria	45
8.1.4 Sample Size Options	46
8.1.5 Tare Options	48
8.1.6 Result Display Options	50
8.1.7 Lift Compensation	52
8.1.8 Linked Test Options	53
8.2. Test Results	54
8.2.1 Graph	56
8.3. Calibration Menu	57
8.3.1 Balance Calibration Menu	57
8.3.1.A View Calibration Report	58
8.3.1.B Perform Span Calibration	59
8.3.1.C Linearity Verification Setup	60
8.3.1.D Perform Linearity Verification	61
8.3.1.E Span Calibration Reminder Setup	62

8.3.2	Temperature Calibration.....	62
8.3.2.A	View Calibration Report	64
8.3.2.B	Verification Setup	65
8.3.2.C	Calibration Module Setup.....	65
8.3.2.D	Perform Calibration	66
8.3.2.E	Perform Verification.....	67
8.3.2.F	Calibration Reminder Setup.....	68
8.4.	Setup Menu.....	68
8.4.1	Printer Setup.....	69
8.4.2	Report Setup.....	69
8.4.2.A	Report Control Options	70
8.4.2.B	Report Items to Print	71
8.4.2.C	Company Name	71
8.4.3	Date/Time Setup.....	72
8.4.4	Ethernet Setup.....	72
8.4.5	Misc Options	74
8.4.6	Nitrogen Control Module	75
8.4.7	Login Setup.....	76
8.4.8	Special Features.....	78
8.5.	Balance Mode	78
8.6.	Parameter Expert.....	79
8.6.1	Develop New Test Program	79
8.6.2	Optimize Existing Test Program	82
8.7.	Sample Foils	84
8.8.	Audit Log	85
9.	WEB SERVER -----	86
9.1.	Calibration Report.....	87
9.2.	LCD View	88
9.3.	Test Programs	89
9.4.	Test Results	90
9.5.	Audit Log	91
10.	PERFORMANCE VERIFICATION-----	92
10.1.	The Weight Test.....	92
10.2.	Sodium Tartrate Test.....	93
10.3.	Retained Samples.....	94
11.	ROUTINE MAINTENANCE-----	94
11.1.	Heat Chamber Cleaning	94
11.2.	Balance Shaft Check	95
11.3.	Heater Cleaning	95
11.4.	Pan Support Cleaning.....	96
11.5.	Lithium Battery Replacement	97
12.	INSTRUMENT PROBLEMS & ERROR MESSAGES -----	97
13.	TEST RESULT PROBLEMS-----	99
14.	APPENDIX A: SAVING & LOADING TEST PROGRAMS -----	101
15.	MAX® 4000 SPECIFICATIONS-----	102
16.	WARRANTY-----	105

3. WARNINGS AND SAFETY INFORMATION

The MAX[®] 4000 moisture analyzer complies with the Underwriter Laboratories Inc. standards and European Council Directives for Electrical Equipment for Laboratory Use, electromagnetic compatibility, and the stipulated safety requirements. The MAX[®] 4000 and its accessories pass Class A emissions. However, improper use or handling of the instrument can result in damage to the equipment and/or injury to personnel.

The MAX[®] 4000 is Equipment Class I, Pollution Degree 2, and Installation Category II. The Temperature Calibration Interface (TCI) is ESD sensitive.

Read these operating instructions thoroughly before using your instrument to prevent damage to the equipment. Keep these instructions in a safe place. An up-to-date electronic copy of this manual can be found on the web site at www.brookfieldengineering.com.

The following instructions will help to ensure safe and trouble-free operation of your MAX[®] 4000.

- Use the instrument only for performing moisture/solids analysis of samples. Any improper use of the instrument can endanger persons and may result in damage to the instrument or other material assets.
- Do not use this instrument in a hazardous area/location; operate it only under the ambient conditions specified in these instructions.
- Although the instrument is simple to operate and is very user friendly, it should only be operated by qualified persons who are familiar with the properties of the sample being analyzed.
- Ensure, before getting started, that the voltage rating printed on the manufacturer's label is identical to your local line voltage (See section **6.3 AC Power Connection** on page **16**).
- The MAX[®] 4000 is provided with a power cord that has a protective ground conductor. Do not operate the instrument without the supplied three-wire power cord or an identical recognized equivalent that meets all applicable standards.
- AMETEK Brookfield does not recommend the use of an extension cord. However, if one must be used, use an extension cord that meets all applicable standards and has a protective ground conductor.
- Do not remove the protective grounding wire from the power supply circuit.
- With the power switch off, power is still applied to the power entry module. Remove the power cord from the MAX[®] 4000 to ensure complete power removal from the instrument.
- Position the power cable so that it cannot touch any hot areas of the instrument.
- Use only factory-supplied accessories and options with the MAX[®] 4000 and check with AMETEK Brookfield before using any third-party accessories, such as printers and analytical balances, to verify compatibility.
- If there is visible damage to the MAX[®] 4000 or its power cord, unplug and isolate the instrument first and then call Customer Service.

- Do not open the housing of the MAX[®] 4000. There are no user serviceable parts or adjustments inside the instrument. Any maintenance inside the instrument is to be performed by factory-trained technicians only. Any unauthorized inspection and/or maintenance of the MAX[®] 4000 will make the warranty null and void.

LITHIUM COIN CELL BATTERY

The MAX[®] 4000 contains a lithium battery to keep power on the clock when the instrument is turned off. **CAUTION** – The battery may explode if mistreated. Do not recharge, disassemble, or dispose of in fire.

PREVENT EXCESS HEAT BUILD-UP AROUND THE INSTRUMENT

- When setting up the instrument, leave enough space to prevent heat from building up and to keep your instrument from overheating. Leave 20 cm (8 inches) around the instrument and 1 m (3 feet) above the instrument.
- Do not put any flammable substances on, under or near the instrument, as the area around the instrument will heat up.
- Use extreme care when removing the sample from the chamber. The heating chamber, the sample itself, the sample pan, and the heating element can still be extremely hot.

HAZARDS FOR PERSONS OR EQUIPMENT POSED BY USING SPECIFIC

SAMPLES: Flammables; explosives; substances that contain flammables, explosives, solvents; and/or substances that release flammable or explosive gases or vapors during the drying process.

- The user shall be liable and responsible for any damage that arises in connection with the MAX[®] 4000 and potentially harmful substances.
- Substances containing toxic, caustic, or corrosive substances may be analyzed with the instrument in an appropriate fume hood only. The fume hood must keep the work area below the lower toxic limit established by appropriate standards.
- Substances that release corrosive vapors such as acids should be analyzed in the smallest sample size possible to still achieve satisfactory results. If vapors condense on the MAX[®] 4000 housing parts, stop the testing, wipe the surface clean with a suitable neutralizer and place the instrument in a fume hood capable of removing the vapors.
- The user has the responsibility for carrying out appropriate decontamination if hazardous material is spilled on or inside the MAX[®] 4000.

CLEANING

- Clean the MAX[®] 4000 according to the cleaning instructions only. Use of strong detergents and “oven cleaners” will damage the case and heater housing of the MAX[®] 4000.
- Before using any cleaning or decontamination method except those recommended by AMETEK Brookfield, check with Customer Service to ensure that the proposed method will not damage the equipment.
- The outside housing of the MAX[®] 4000 should be cleaned with a mild household detergent such as Formula 409[®] and a soft, lint-free cloth. Paper towels should never be used, as they will scratch the instrument’s finish and the clear lens over the display. If methods that are more stringent are required, call Customer Service for recommendations.

- Every precaution has been taken to prevent contaminants from entering the instrument. However, if liquids or powders do enter the case, call Customer Service for recommendations.

The user shall be liable and responsible for any damage that arises in connection with the use of this instrument.

ENVIRONMENTAL CONDITIONS

- STORAGE AND SHIPPING
 - Temperature should be between 0 °C and +40 °C (+32 °F and +104 °F).
 - Relative Humidity should be between 10% and 80%.
- OPERATIONAL CONDITIONS – INDOOR USE.
 - Optimum results will be achieved when the instrument is set on a smooth, level, non-vibrating surface in a non-condensing, non-explosive environment of 0 - 40 °C at 50% relative humidity or 0 - 30 °C at 80% relative humidity.
 - Do not expose the instrument unnecessarily to extreme temperatures, moisture, shocks, blows or vibration.

WARNING SYMBOLS



Protective Ground:
Identifies the connection on the chassis and power inlet module for the safety ground (green/yellow) wire connection.



Warning:
Observe information or procedures



Electrical Shock Hazard:
Observe all steps of the procedure to prevent electrical shock.



Warning - Hot surface or area of possible severe burns:
Use listed precautions when opening the oven lid and handling samples to prevent injury.

4. PACKING AND SHIPPING INSTRUCTIONS

IMPORTANT

Movement, handling, and packaging of the instrument must be done with **EXTREME CARE** to avoid permanent, expensive internal damage. The MAX[®] 4000 uses a delicate and very sensitive electronic force balance to measure small weights and weight losses. The balance is capable of measuring weight to a resolution of 0.1 milligrams. Careful handling is necessary to prevent damage to the balance. With proper care, the instrument will provide years of dependable service.

UNPACKING

- Unpack the instrument carefully and set it down gently. Select a place where it will be safe from bumping, jarring, excessive air currents, and vibration.
- Check the instrument immediately for any visible damage resulting from rough handling during shipment.
- Retain the box and all packaging materials for any future shipment of the instrument. If the instrument is returned to AMETEK Brookfield for any reason, place it in the original packaging materials. Only the original packaging materials have been tested and proven effective during shipment.
- Install the pan support:
 - Open the lid by lifting the handle just above the display.
 - Remove the yellow tape, pan support and packing foam.
 - Save the foam so that it can be taped in place when the instrument is returned to the factory for annual calibration.
 - Gently but firmly install the pan support into the balance stem.

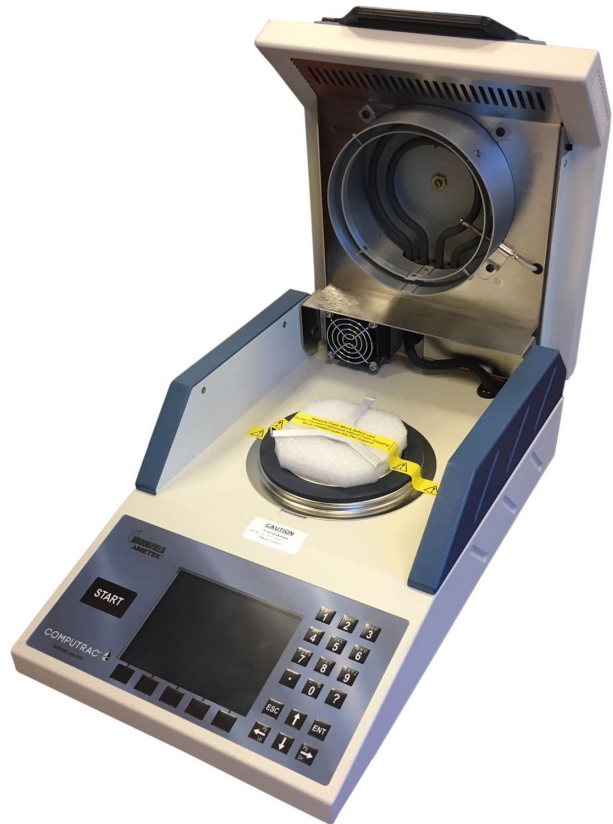

REPACKAGING FOR SHIPMENT

- Call AMETEK Brookfield Customer Service for Return Material Authorization (RMA) information prior to returning an instrument.
- Boxes and packing materials are available from AMETEK Brookfield for all shipments.
- Pack the MAX[®] 4000 in a Computrac[®] MAX[®] 4000 shipping container. Use the packing diagram below that matches your shipping system as a guide. If using the foam on the right below, orient the bottom foam tray as shown. A packing guidance diagram is also included on one of the box flaps.
- **Be sure to place the foam block underneath the pan support when packing the instrument. See UNPACKING (on the previous page) for pictures and more information.**

AMETEK BROOKFIELD WILL NOT BE RESPONSIBLE FOR SHIPPING DAMAGE. IF YOU RETURN THE INSTRUMENT IMPROPERLY PACKAGED OR SHIPPED, YOU SHOULD INSURE IT FOR FULL VALUE.

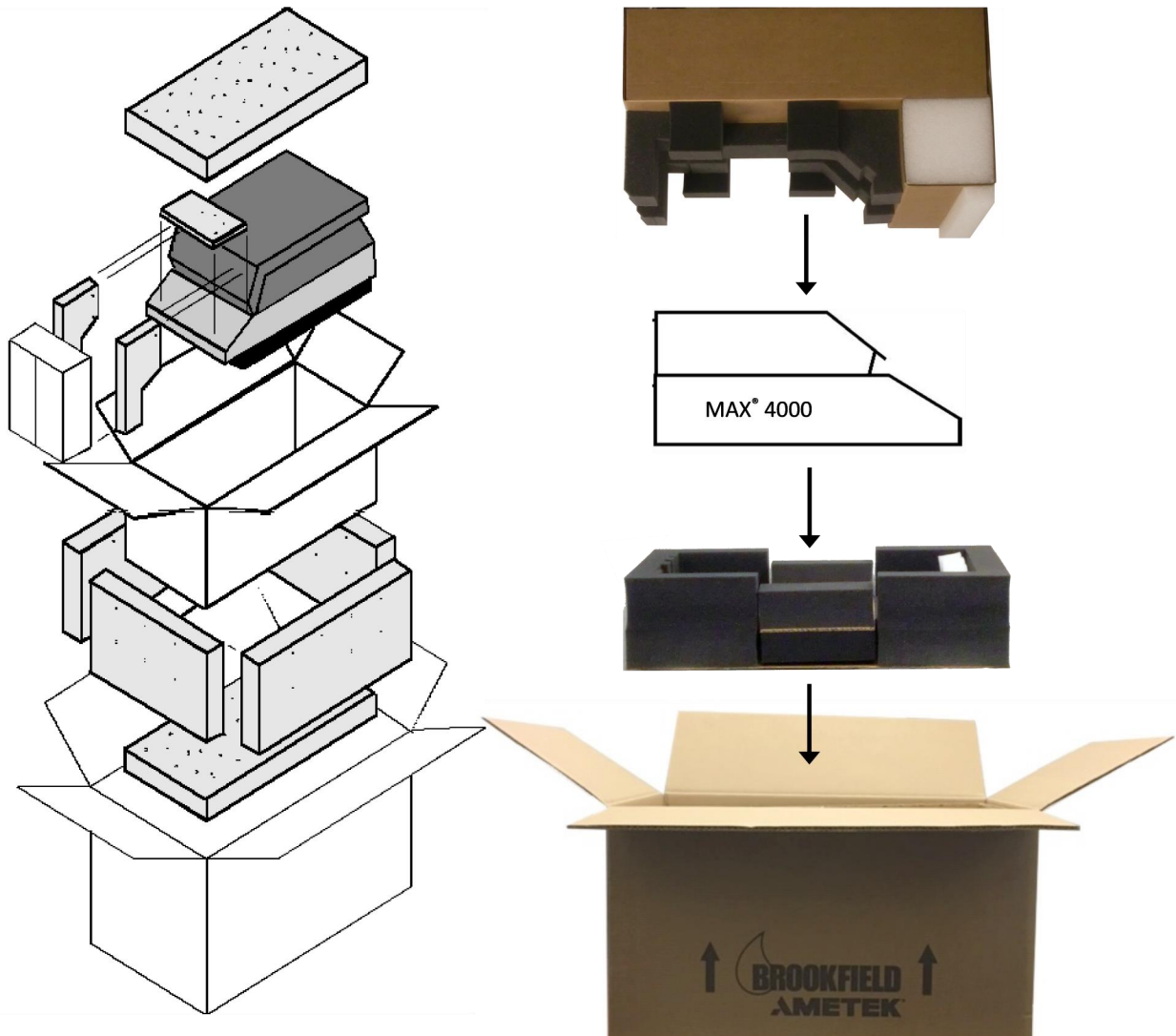

5. INTRODUCTION

The Computrac[®] MAX[®] 4000 and MAX[®] 4000XL are high performance programmable loss-on-drying analyzers with the following features:

- Typically, the instrument results are precise to better than:
 - 0.002% SD typical for < 0.020% moisture (MAX[®] 4000XL only)
 - 10% RSD from 0.020% - 0.100% moisture (MAX[®] 4000XL only)
 - 2.0% RSD from 0.100% - 100% moisture (MAX[®] 4000 and MAX[®] 4000XL)
- Programming is through the front panel keypad with a user-friendly menu system.
- A color LCD that is easy to read and provides color graphing.
- AMETEK Brookfield's pioneering prediction method that can automatically end a test to provide accurate results in the shortest possible time.
- Test temperatures that can be set at one degree increments from 25 °C to 275 °C on the MAX[®] 4000XL. (25 °C to 225 °C on the MAX[®] 4000).
- Programmable for 250 Test Programs for different materials, including 245 user programs and 5 factory programs on the MAX[®] 4000XL. (The MAX[®] 4000 has 6 user programs and 4 factory programs.)
- Test Results:
 - On the MAX[®] 4000XL, the last 1,000 Test Results are stored in the instrument along with the last 100 Test Graphs. (The MAX[®] 4000 stores 2 Test Results and does not have Test Graphs.)
 - Tests Results can be viewed, printed, and downloaded using Internet Explorer[®] (with the optional Web Server only available on the MAX[®] 4000XL), or sent to a PC over a USB or serial port.
 - The mean, standard deviation and relative standard deviation can be calculated for test results.
 - Moisture graphs can be viewed and printed. (Only available on the MAX[®] 4000XL)
- A lid fan that rapidly cools the heat chamber to reduce time between tests to increase overall throughput.
- In addition to moisture analysis, the instrument can function as an analytical balance.
- Periodic balance and temperature calibration to maintain accuracy.
- Balance linearity verification across the full range of the balance. (Only available on the MAX[®] 4000XL).
- A Parameter Expert feature (only available on the MAX[®] 4000XL) that assists a user with the development of a Test Program that will produce results that match a reference method.
- An optional Web Server (only available on the MAX[®] 4000XL) allows a user with Internet Explorer[®] to:
 - Download a complete calibration report.
 - View the LCD screen
 - Download and upload Test Programs.
 - Download Test Results and Test Graph data
 - Download the Audit Log
- An Audit Log that tracks test program changes, calibrations, test result deletions, system errors, and power on events. (Only available on the MAX[®] 4000XL).

- A User Login function that, if activated, can be used to restrict access to calibration functions and instrument and test configuration options except by authorized users, preventing unwanted changes to operating parameters. When User Login is active on the MAX[®] 4000XL, a user is required to login prior to testing, and the username is recorded with each test result.
- On 21 CFR, Part 11 compliant instruments, the Delete Test Results and Delete Audit Log Events functions are disabled throughout the system.



For those familiar with moisture analysis instruments, the MAX[®] 4000 should be simple to operate. However, please read all of the sections in this manual before attempting your first analysis.



Contact Customer Service if you have any questions about the following instructions. An up-to-date electronic copy of this manual can be found on the web site at www.brookfieldengineering.com.

5.1. Hardware

The MAX[®] 4000 series instruments consist of:

- A small oven that dries the sample.
- A precision balance weighing mechanism with a resolution of 0.001 gram (0.0001 gram on the MAX[®] 4000XL) and a full-scale range of 40 grams that continuously weighs the sample.
- An input power module that can be set to 100-120 VAC or 220-240 VAC.
- A large backlit color graphic LCD.
- A 32-bit microprocessor that controls the test process, data handling, communications, and performs all necessary calculations.
- A lid fan that rapidly cools the heat chamber to reduce time between tests to increase overall throughput.
- A small fan in the lower chassis that maintains the electronics at a stable and low temperature.
- Connectors on the back panel include:
 - A USB Type A / Host port for connecting a USB printer, a USB keyboard, a Nitrogen Control module, a bar code reader, and/or other accessories.
 - An RS-232 serial port for PC connection and Temperature Calibration Interface (TCI) module connection.
 - An Ethernet connection for using the optional Web Server. (MAX[®] 4000XL only).
 - A USB Type B / Slave port for connecting a computer to the MAX[®] 4000.

The MAX[®] 4000 is designed to remain powered up at all times. From a cold start, the instrument requires a 60-minute warm up period for optimum accuracy. When the instrument is not in use, select a test with an idle temperature of 25 °C and keep the lid down. The oven will remain cool, and the LCD backlight will turn off after a period of inactivity to conserve energy. Press any key or open or close the lid to restore illumination to the LCD.

5.2. Instrument Models

There are 2 different instrument models in the MAX[®] 4000 series, the MAX[®] 4000 and the MAX[®] 4000XL, which have various feature differences, as detailed below. Throughout this manual, MAX[®] 4000 is used to refer to both the MAX[®] 4000 and the MAX[®] 4000XL when describing common features or functionality. When there are specific differences between the two models, these are indicated through the usage of MAX[®] 4000XL for features that are only available in the MAX[®] 4000XL. Refer to the label on the front of the instrument, the splash screen displayed during power-up or access the **Special Features** menu (see page 78) to determine which model instrument you have.

FEATURE	MAX [®] 4000	MAX [®] 4000XL
Moisture Range	0.1 to 99.9%	0.005 to 100%
Balance Resolution	0.001g	0.0001g
Test Result Storage Count	2	1000
Factory Test Program Count	4	5
User Test Program Count	6	245
Max Test Temperature	225	275
Test Temperature Rate Control	No	Yes
Test Ending Criteria	Rate or Prediction	All
Minimum Rate Setting for Rate Ending Criteria	0.01%/minute	0.0010%/minute
Custom Result Equations	No	Yes
Result Resolution (decimal points)	Fixed At 2	Adjustable
Linked Tests	No	Yes
Allow Moisture Gain	No	Yes
Graphing	No	Yes
Perform Temperature Calibration & Verification	No	Requires Temp Calibration Kit
Perform Balance Linearity Verification	No	Yes
Parameter Expert	No	Yes
Web Server	No	Optional
Audit Log	No	Yes
User Login	Yes	Yes

Contact your technical sales representative for more information on the different models.

5.3. Oven

The sample oven is designed to remove volatile components from the sample as quickly as possible, while maintaining accurate temperature control to prevent sample degradation. Oven temperature is measured with a Resistance Temperature Device (RTD), mounted in a rugged metal tube to prevent damage and dislocation. Temperature control accuracy is within one degree of the set value after equilibrium is reached, and the 700-watt heater reaches equilibrium in 90 to 180 seconds, depending on the difference between the starting and setpoint temperatures. Closed loop feedback control assures a constant temperature even if power line voltage varies during the test. After a test is completed, the heating system is turned off and the lid cooling fan is turned on. **If desired, open the lid after testing to speed cooling before performing the next test.**

5.4. Inventory & Accessories

Carefully unpack the instrument and locate the following items:

Part Name	Part Number
MAX [®] 4000 MAX [®] 4000XL	MAX-4000 / MAX-4000XL
Pan Support Assembly	600-0152
Accessory Kit:	Y990-0209
Line Cord, 110 VAC	200-0002
or Line Cord, 220 VAC (Europe)	200-0233
or Line Cord, 220 VAC (UK)	200-0234
Test Weights (ASTM Class 5):	
3 grams	690-0003
5 grams	690-0004
20 grams	690-0007
Tweezers	690-0012
Hex wrench for pan support	690-0016
User Manual	700-0111
Quick Guide	700-0120
Sample Pans, Waffle XT (100 Pcs)	990-0233
Optional Accessories	
Bar Code Reader	GV-1412
DC to AC Inverter Kit	Y990-0251
Filter Bracket Kit	Y990-0211
IQQPQ Validation Package (for MAX [®] 4000XL)	Y990-0228
Nitrogen Purge Kit	Call Customer Service
Nitrogen Control module	Y990-0214
Null modem cable for PC connection	6000-1044
Color Printer Kit (includes printer & USB cable)	Y990-0212
Black & White Mini-Printer Kit (Includes printer, USB cable & thermal paper)	Y990-0252 (Add'l Paper: 6100 0050)
Rear Port Dust Covers Kit	Y990-0250
Sample Basket	600-0137
Shipping Container	751-0011
Temperature Calibration Kit, 110-240V	Y990-0156
Test Weight – 10 gram (ASTM Class 5)	690-0005
USB Cable for Printer or PC connection	200-0165
USB Keyboard	990-0230
USB Flash Drive	990-0241
USB Hub	990-0232
Web Server	Y990-0232
Consumables:	
External Dust Filter	800-0071
Filter Paper	990-0003
Sample Pans, Flat Bottom (100 Pcs)	990-0010
Sample Pans, Waffle XT (100 Pcs)	990-0233
Sodium Tartrate (500-gram bottle)	800-0037
Spare Parts:	
4 Amp Fuse	190-1002
8 Amp Fuse	190-1001

6. INSTRUMENT SETUP

Review and perform all necessary setup steps in section 6 (including its subsections). After setting up the instrument, complete the following three items before testing any samples with the instrument:

- Perform a balance span calibration (See section **8.3.1.B Perform Span Calibration** on page **59**).
- Perform weight tests to verify proper performance and to get familiar with instrument operation (See section **10.1 The Weight Test** on page **92**).
- Set up a test program to run material tests (See section **7 MOISTURE ANALYSIS TESTING** starting on page **33**.)

6.1. Instrument Location

The MAX[®] 4000 is designed to provide reliable results under normal ambient conditions in the laboratory and on the production floor. Compliance with the following guidelines will help ensure optimum accuracy and minimum test times:

- Locate the instrument on a firm and level surface that is free from vibration that will affect the balance measurements.
- Locate the instrument close to an isolated power outlet that will provide dedicated electrical power.
- Locate the instrument away from a fan, heating/air-conditioning vent, or drafts from a window/door that might produce force on the balance.
- Maintain an operational clearance of 20 cm (8 inches) around the instrument and 1m (3 feet) above the instrument.
- Keep all cables as short as possible (less than 2 meters (6 feet) in length if possible).
- Avoid placing the instrument in close proximity to a heater or otherwise exposing it to heat or direct sunlight.
- Avoid exposing the instrument to extreme temperature fluctuations.
- Keep the instrument protected from dust, liquids, and caustic vapors as much as possible.
- Do not expose the instrument to saturated humidity environments. Moisture in the air can condense on the surfaces of a cold instrument whenever it is brought into a substantially warmer place. If you move the MAX[®] 4000 to a warmer area, make sure to condition it at room temperature by disconnecting it from AC power for at least 2 hours or until moisture condensation no longer occurs.

6.2. Interior of Test Chamber & Pan Support



CAUTION - Do not, at any time, attempt to spin the pan support as it may result in damage to the force balance. Avoid excess pressure on the pan support from the top or sides, which can damage the force balance.



If not already installed, gently but firmly install the pan support into the balance stem.

Check the clearance between the pan support arms and the shroud gasket by observing the space between the arms and the shroud gasket. The clearance should be between 1.9mm (the thickness of an American nickel) and 3mm (the thickness of a nickel and a dime stacked). If the clearance is considerably different, or the pan support appears to be crooked, call Customer Service.

6.3. AC Power Connection

Power Requirements: 100-120 VAC, 50/60 Hz @ 8 Amps – fuse is F8A T250V
220-240 VAC, 50/60 Hz @ 4 Amps – fuse is F4A T250V
Fused on/off switch is part of an EMI power entry module

The MAX[®] 4000 can be used with a 100-120 VAC or a 220-240 VAC input power source. Check the setting on the fuse holder, located at the rear of the instrument, and make sure it is set for the correct voltage for your environment.



Ensure that the power entry module (where the power cord connects to the instrument) is set for the correct voltage for your environment.



To change the voltage from 110 to 220VAC or 220 to 110VAC:

- Remove the power cord.
- Pry the fuse holder from the power entry module.
- Ensure only 8-amp timed fuses are installed for 100-120 VAC operation or only 4-amp timed fuses are installed for 220-240 VAC operation
- Rotate the fuse holder 180° and reinstall it in the power entry module, making sure that the arrow on the power entry module is pointing to the proper voltage for your environment.

Connect power to the instrument:

- Ensure that the power switch, located on the power entry module in the back of the instrument, is set to off (O).
- Remove the power cord from the packing material and insert the rectangular end into the power entry module.
- All non-USB accessory equipment, printer, computer, etc., should be connected before applying power to the instrument. See sections **6.7 Connecting a USB Printer** on page 21 and **6.9 Connecting a Computer** on page 22 to connect a printer and/or computer.



For best results, a **DEDICATED** electrical power outlet is recommended. Do not put it on a circuit with motors, blenders, heaters, coolers, grinders, or other high current electrical devices.

The power source outlet that is used by the MAX[®] 4000 **MUST BE GROUNDED**. (If you are not sure if the socket is grounded, check with your plant electrician before proceeding). **The MAX[®] 4000 will appear to function correctly even if the socket is not grounded, but there is a danger of possible electrocution! If grounded outlets are not available, consider using a ground fault interrupter to protect personnel against electrical shock.**



- Plug the power cord into a dedicated electrical power outlet. Line noise on the power lines may affect accuracy. A dedicated AC power line or an isolation transformer for the MAX[®] 4000 may be beneficial in eliminating this noise.
- Turn on the instrument by flipping the switch on the power entry module on the back of the instrument; the instrument is designed to remain powered up at all times.
- From a cold start, allow the instrument to warm-up for 60 minutes before testing.

6.4. User Interface Operation

- After power up, the Main Test screen shown below appears. (It may be necessary to press the **[ESC]** key to clear any calibration reminders).

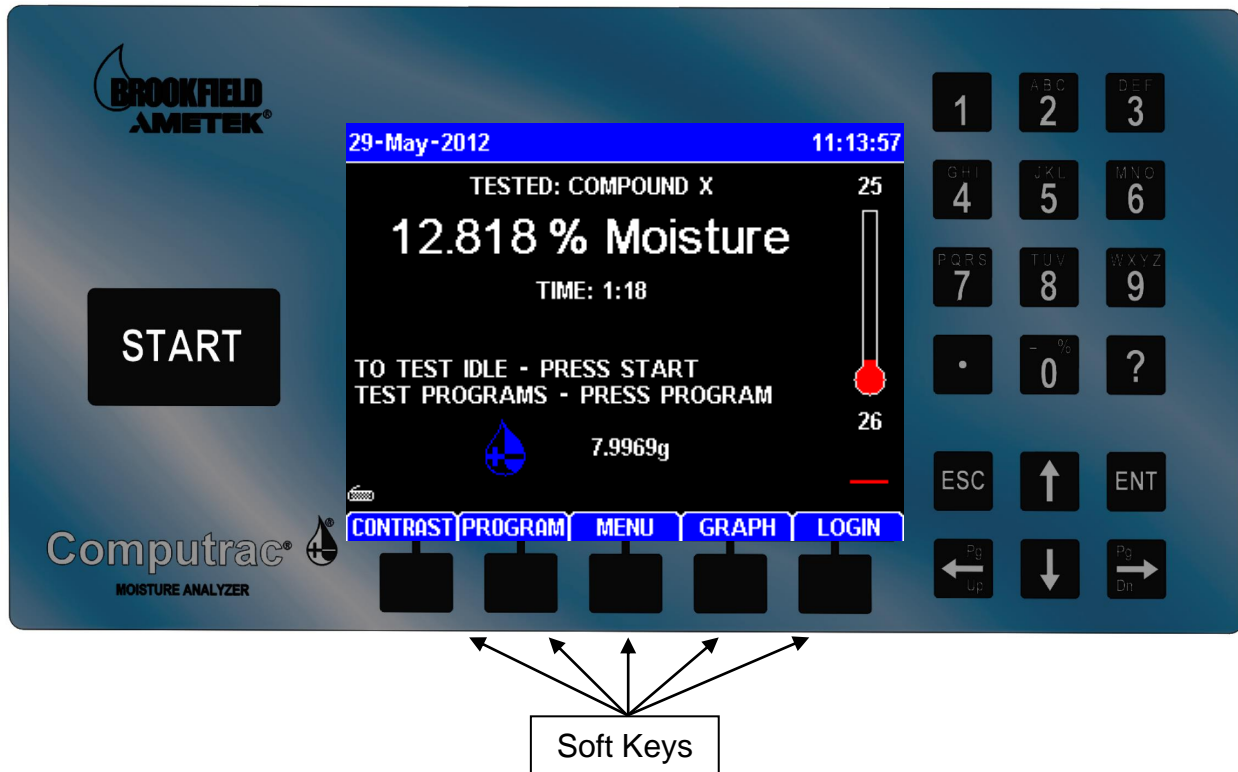

The keypad button functions are as follows:

- **[START]** - Begins a test using the currently selected Test Program.
- **Left and Right Arrow Keys:**
 - Move the cursor to the prior or next item on edit screens.
 - Move the cursor one page prior or following on list screens.
- **Up and Down Arrow Keys:**
 - Move the cursor to the prior or next item on edit screens.
 - Move the cursor one line up or down on list and menu screens.
 - Move the cursor up or down while editing a list of items.
- **Numeric Keys:**
 - Select the numbered item on menu screens.
 - Move to the item on list screens. The last numeric digit of the item is used when the choices are two-digit numbers. For example, the 7 key could be used to select 7, 17 or 27, etc., depending on the choices displayed on the instrument.
- **[ENT] (for ENTER):**
 - Selects most items.
 - Toggles **Yes/No**, **On/Off**, and Checked (✓) items.
- **[ESC]** - Exit a menu or screen. Items that are **Yes/No** or **On/Off** choices are saved when the **[ESC]** key is depressed to end editing of the item.
- **Soft Keys** are located below the instrument's display and the functions that they perform are indicated by the titles located above each soft key on the display. These functions are related to the current operating mode of the instrument and will vary accordingly.

To begin editing an item either:

- Press **[ENT]** to edit the existing value.
- Press an **Alphanumeric** or **Numeric** key to overwrite the existing value with a new value.

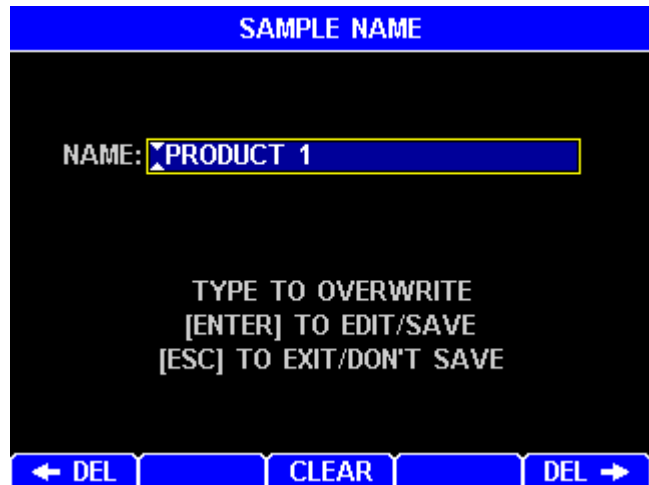

Typical keys during item editing are:

- **Left and Right Arrow Keys** – Move the cursor one position left or right.
- **Alphanumeric Keys** – For alphanumeric items, press the key repeatedly to scroll through the listed characters plus a blank space (similar to cell phones). After a short delay, the alphanumeric digit is saved to the item allowing a new digit to be added. For example, press the 2 key once for an “A”, twice for a “B”, thrice for a “C”, four times for a “2”, and five times for a blank space. After the blank space, repeated button presses start the cycle over at “A”. Note, the 0 (zero) key contains the dash and percent symbols.
- **Numeric Keys** – For numeric items, add a numerical digit.
- **[←DEL]** or **[DEL→]** – Delete the character to the left or right of the cursor.
- **[CLEAR]** – Erases all characters in the item.
- **[+/-]** - Change the polarity (positive or negative sign) of a number. This is only displayed when applicable.
- **[ENT]** – Save the edited value and advance to the next item, if one is present.
- **[ESC]** – Exit an item edit without saving the value (unless it is a **Yes/No** or **On/Off** item).

6.5. Contrast Adjustment

If necessary, adjust the display contrast controls for better viewing of the display. At the Main Test screen, the leftmost soft key below the display has the word **CONTRAST** above it. Press this key and the display changes to instructions on setting the contrast. Use the up and down arrows on the keypad until the display is acceptable and press the **[ESC]** key to save the setting and exit back to the Main Test screen.



During normal operation, the LCD will darken after 30 minutes of inactivity but will brighten with any key press or lid opening or closure. The optional Web Server LCD view is not affected.

6.6. Back Panel Connections

In addition to the AC power connection, these connections are also available from the back panel of the instrument:

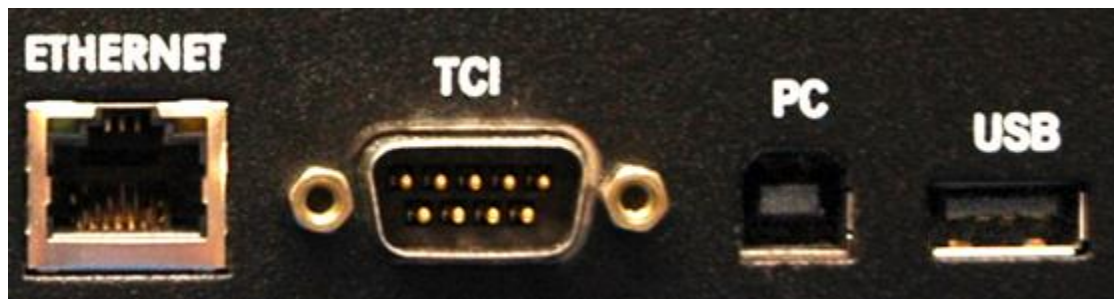

- RJ-45 Ethernet Connection (marked **ETHERNET**)
 - The Ethernet port is used primarily to connect the MAX[®] 4000XL to a Local Area Network (LAN) for use with the optional Web Server. See section **9 WEB SERVER** on page **86** for more information.
- Temperature Calibration Interface and RS-232 serial port (marked **TCI**)
 - The TCI port is used primarily to connect the Temperature Calibration Interface when performing Heater Temperature Calibration on the MAX[®] 4000. See **Temperature Calibration** on page **62** for more information. This port is also used to connect to a PC using a serial cable. See **Connecting a Computer** on page **22** for more information.
- USB Type B / Slave Connection (marked **PC**)
 - The USB Type B connection is used to connect the MAX[®] 4000 directly to a PC using a USB A to B cable (P/N: 200-0165). See **Connecting a Computer** on page **22** for more information.
- USB Type A / Host Connection (marked **USB**)
 - The USB Type A connection can be used to connect various accessories, including a USB printer, a USB drive, a USB keyboard, a bar code reader or a Nitrogen Control module. An icon (shown below) will appear in the bottom left corner of the main screen indicating the type of USB device connected. To connect more than one accessory at one time, a USB hub is required. Some accessories, such as the Nitrogen Control module, require a powered USB hub that connects to AC power in order to function. For best results, if a USB hub is used with the MAX[®] 4000, a powered hub (P/N: 990-0232) is recommended.
 - For additional information on these accessories, see:



USB Type B



USB Type A



6.7 Connecting a USB Printer on page **21**



6.8 Connecting a USB Drive on page **22**



6.10 Connecting a USB Keyboard on page **27**



6.12 Nitrogen Control Module on page **29**



6.13 Bar Code Reader on page **31**

6.7. Connecting a USB Printer



Two optional graphics capable printers are available from AMETEK Brookfield:

- Color Printer Kit P/N: Y990-0212
- Black and White Mini-Printer Kit P/N: Y990-0252

The printers connect to the USB Type A / Host port (marked **USB**) on the back panel. Test Programs, Test Results and graphs, and calibrations can be printed. The reports can be custom configured through the menu system. These same reports can be directed to a computer through the USB Type B / Slave port (marked **PC**) or RS-232 TCI serial port on the back panel.

To set up the printer:

- Unpack the printer and cable.
- Load the ink cartridges (if any) and paper according to the printer instruction manual.
- Plug the USB connector of the printer cable into the printer's mating socket and the Type A rectangular connector of the cable into the MAX[®] 4000's mating socket (marked **USB**). If other USB devices are being used, a USB hub is needed to connect multiple devices to the MAX[®] 4000.

- Plug the power cord into the printer, and into a GROUNDED power receptacle.
- Turn on the printer.
- Turn on the MAX[®] 4000, if not on.
- When a printer is connected, a printer icon will appear in the bottom left corner of the main screen, above the CONTRAST soft key. The icon varies depending on which printer is connected:
 -  Standard Printer
 -  Mini-Printer



- To configure the MAX[®] 4000 for printer use, go to section **8.4.1 Printer Setup** on page **69**.
- To configure test report options, go to section **8.4.2 Report Setup** on page **69**.
- Verify printer operation by printing a test result or calibration. For example:
 - Begin at the Main Test screen and press **[MENU]**, (the center soft key below the display) to access the Main Menu.
 - Select the CALIBRATION MENU item and press **[ENT]**.
 - Select the BALANCE CALIBRATION MENU item and press **[ENT]**.
 - Select the VIEW CALIBRATION REPORT item and press **[ENT]**.
 - Select the **[PRINT]** soft key and verify the report prints.
- If the printer runs out of paper while printing, printing to the printer will cease and the print job will be purged. Printing to the PC, USB drive or a 2nd attached printer will not be affected. To continue, refill the printer with paper and reprint the desired print job.

If you have any questions about connecting a printer to your MAX[®] 4000, call Customer Service.

6.8. Connecting a USB Drive

If you wish to monitor testing using a USB drive (P/N: 990-0241), one can be connected to the USB Type A / Host port (marked **USB**) on the back of the MAX[®] 4000. For best results, use AMETEK Brookfield Flash Drives (P/N: 990-0241) that have been validated for use with the MAX[®] 4000. Compatibility with non-AMETEK Brookfield USB drives cannot be guaranteed.

See section **8.4.1 Printer Setup** on page **69** for instructions on configuring the instrument to send reports to the USB drive. USB drives that contain the U3 program are not compatible with the MAX[®] 4000 and should not be used.

The MAX[®] 4000 can send data to a computer, a USB drive, and a printer port at the same time. However, graphs that can be printed by the printer are not formatted for display by the computer or USB drive. Therefore, graphs are not sent to the computer or USB drive.

When a USB drive is connected, the USB drive icon will appear in the bottom left corner of the main screen, above the CONTRAST soft key.



If you have any questions about connecting a USB drive to your MAX[®] 4000, call Customer Service.

6.9. Connecting a Computer

If you wish to monitor testing with a PC, a PC can be connected to the MAX[®] 4000 with a USB cable (P/N: 200-0165) or a null modem cable (P/N: 6000 1044).



**Before connecting the MAX[®] 4000 to a PC with a USB cable, install the USB driver first.
See section 6.9.1 USB Driver Setup on page 23.**



To use a null modem cable, connect the TCI serial port on the MAX[®] 4000 back panel to a PC serial port.

For either a null modem or USB connection:

- Use any serial port communications program on your PC to read the reports transmitted from the MAX[®] 4000. (Most pre-Vista Windows[®] PC's come with HyperTerminal in the PC's Start/Accessories/Communications menu; for later versions of Windows[®], there are numerous open-source terminal emulation programs available online that can be configured to communicate with the MAX[®] 4000). If using a null modem cable, configure the PC to use 115.2kbits/s, 8 data bits, no parity, 1 stop bit, and no flow control. USB connections do not require configuration.
- The MAX[®] 4000 does not test to see if the computer is actually connected or ready to receive data. It does not respond to a request from the computer for status information.
- The MAX[®] 4000 can send data to a computer, a USB drive, and a printer port at the same time. However, graphs that can be printed by the printer are not formatted for display by the computer or USB drive. Therefore, graphs are not sent to the computer or USB drive.

If you have any questions about connecting a computer to your MAX[®] 4000, call Customer Service.

6.9.1 USB Driver Setup

Before using the computer to receive information from the MAX[®] 4000 through the USB port, the USB driver must be installed on the PC. The USB driver is on the CD with this manual and on the Drivers page of the website at www.brookfieldengineering.com. The driver works with Windows[®] XP (32-bit) through Windows[®] 10.

If the CD is available:

- Insert the CD in the PC's CD-ROM drive.
- Use Windows[®] to browse to the CD, locate the driver file (AMETEK_USB_Driver.zip), and copy it to your desktop.

If the CD is not available:

- Download the driver file from the Drivers page at www.brookfieldengineering.com and save it to your desktop. If you received these instructions and the driver in an email, save the attached file (AMETEK_USB_Driver.zip) to your desktop.

Once the driver file (AMETEK_USB_Driver.zip) is on your desktop:

- Double-click the file to open it.
- Drag the "Driver Install" directory from the zip file to the desktop.
- Double-click the "Driver Install" folder to open it.
- Double-click the "Install Driver" shortcut. This will launch the AMETEK Driver Installer wizard.

Follow the instructions in the AMETEK Driver Installer wizard.

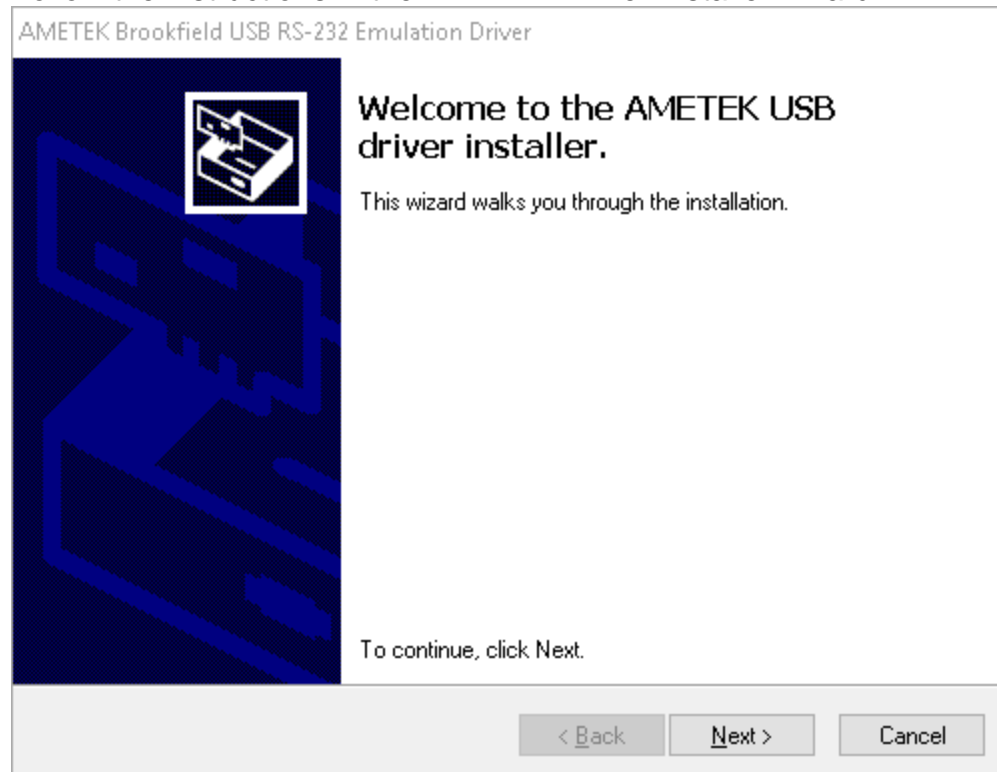

- Click Next.

Windows® may display a Windows® Security message. The driver being installed is a generic Communications Port driver that is part of Windows® (usbser.sys), so it is safe to ignore this warning.

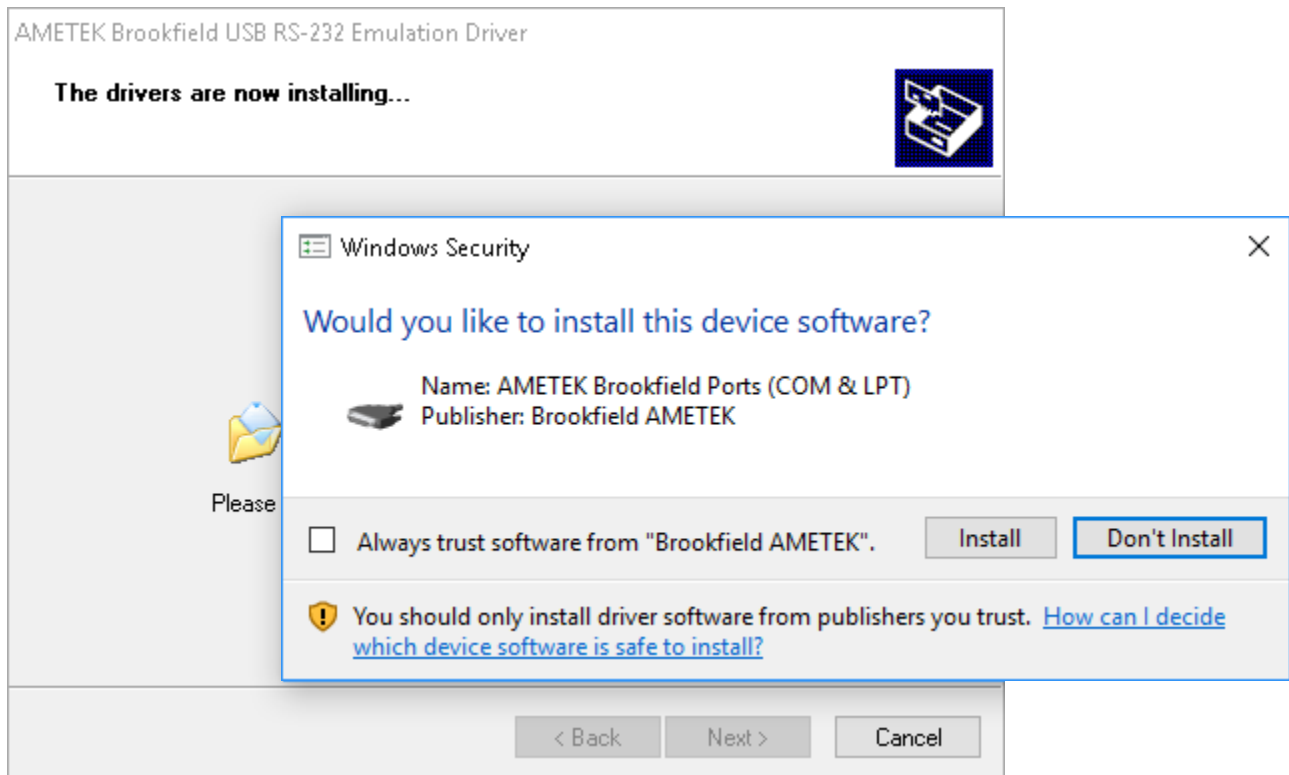

- Click "Install" to continue.

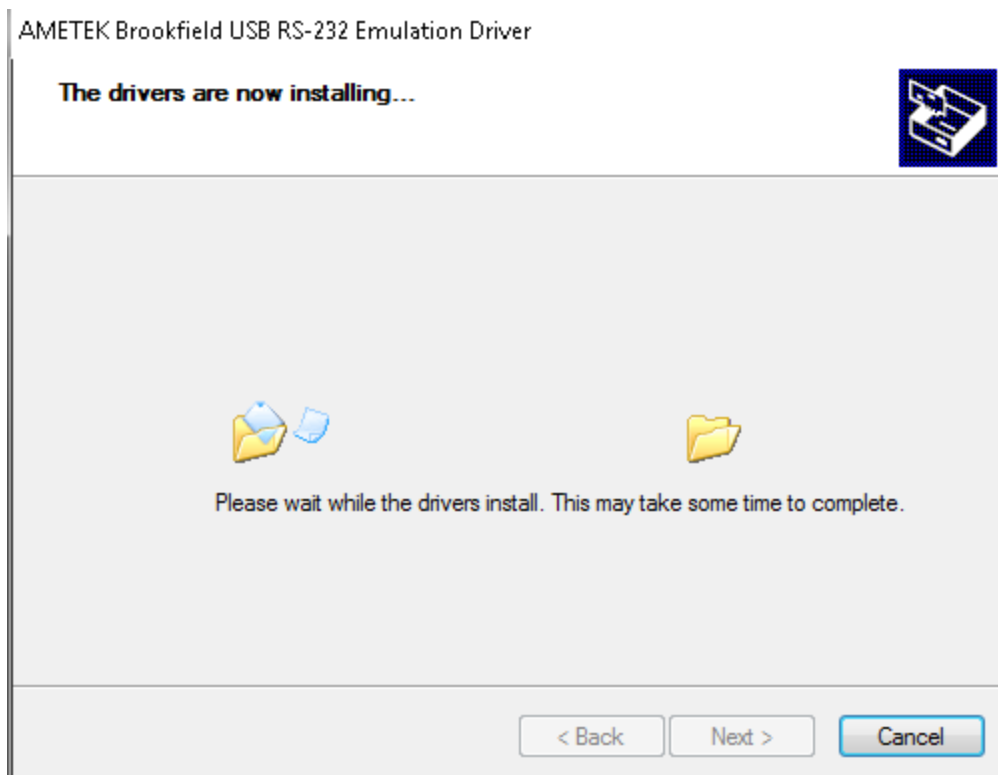

- Wait for the Driver to finish installing.

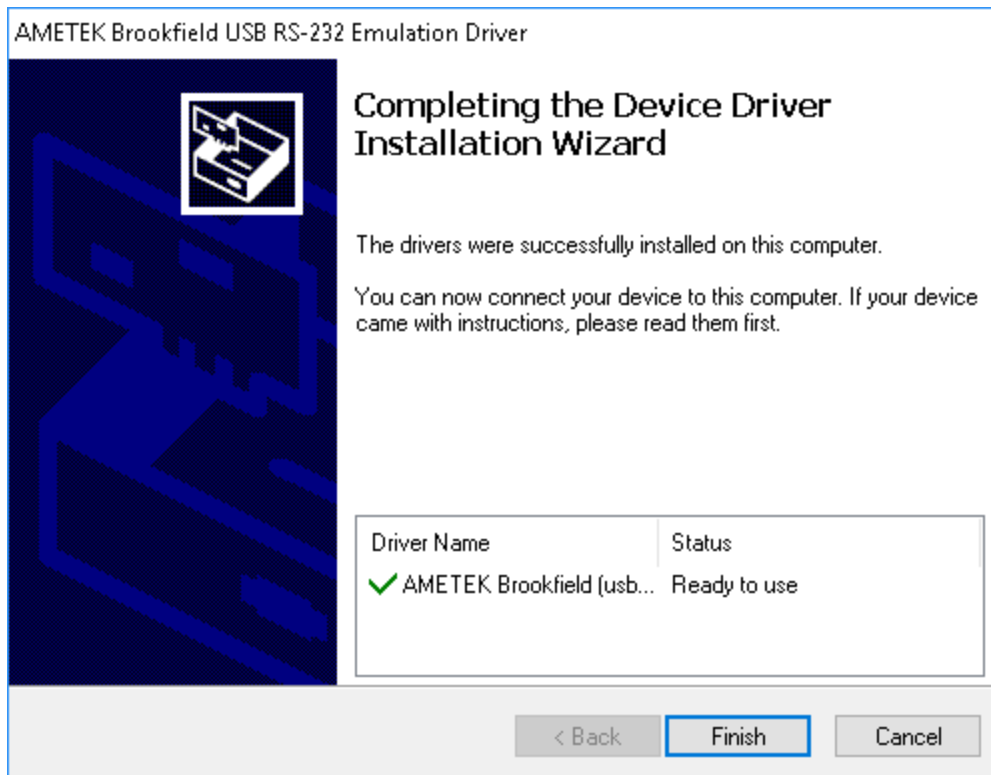

- Click Finish to complete the installation.
- Connect the instrument to the target computer using a USB A-to-B cable (P/N 200-0165) and power on the instrument. Windows® will detect the instrument and automatically install the device driver software, as indicated by the appearance of two pop-up balloons, possibly followed by the confirmation dialog shown on the next page.

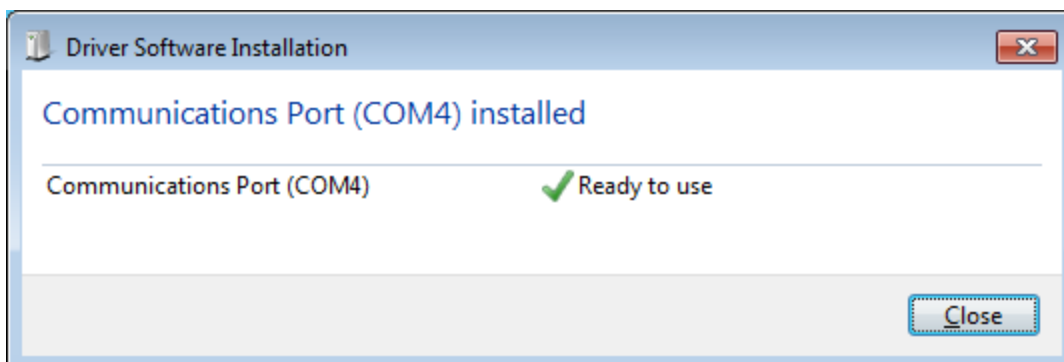
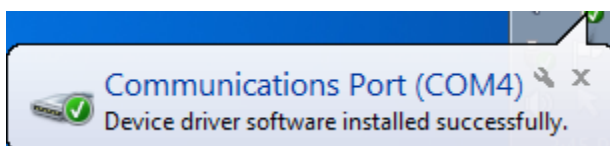
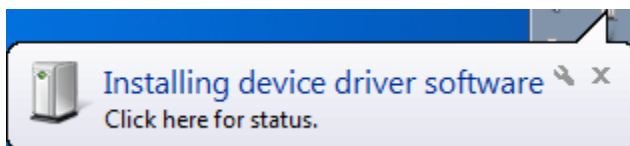

To determine what Windows® COM port was selected by the driver (if the COM Port number was not indicated in the pop-up balloon or dialog above), open the Control Panel (in Small or Large icons view) and open the Device Manager. Expand the Ports (COM & LPT) list and view the available Serial Ports.

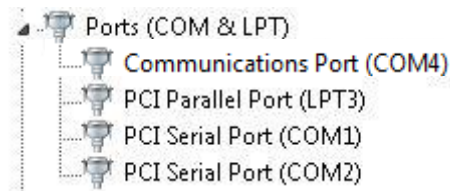

In this example, COM4 is the new port. To verify, unplug the USB cable from the instrument and watch the communications port disappear from the list.

Make note of the COM port in use, as this information will be needed when setting up the serial port communications program to communicate with the instrument.

6.10. Connecting a USB Keyboard

An optional keyboard is available from AMETEK Brookfield (P/N: 990-0230) that allows easier text entry. It connects to the USB Type A / Host port (marked **USB**) on the back panel. The keyboard can be used as a substitute for the alphanumeric keypad, and the arrow, **[ESC]** and **[ENT]** keys, and the keyboard function keys F1→F5 can be used to activate the soft keys. However, the keyboard cannot substitute for the **[START]** button.

- Unpack the keyboard.
- Plug the end of the keyboard cable into the MAX[®] 4000's mating USB socket (marked **USB**). If other USB devices are being used, a USB hub is needed to connect multiple devices to the MAX[®] 4000.
- When the keyboard is connected, the keyboard icon will appear in the bottom left corner of the main screen, above the CONTRAST soft key.



Note, however, that the bar code reader also acts like a USB keyboard and only one keyboard device can be connected to the MAX[®] 4000 at a time. To use the keyboard, the bar code reader must first be disconnected from the instrument or USB hub, and vice versa. For more information on the bar code reader, see section **6.13 Bar Code Reader** on page **31**.

6.11. Nitrogen Purge Use

Some applications may require the use of a nitrogen purge to remove volatiles from the chamber.



CAUTION - Use of nitrogen or other inert carrier gas does not create an explosion-proof system.



CAUTION – Please Call AMETEK Customer Service for Nitrogen Purge Kit Installation



The following items are required for the nitrogen purge setup:

- Nitrogen source/cylinder or other supplied inert gas source.
- Two-stage regulator capable of regulating pressure to 5 psi:
 - For cylinder applications: Multi-stage Gas Regulator for Compressed Air Cylinder, VWR #55850-420 or equivalent.
 - For supplied gas sources: Matheson Gas Products Model 3471 Single Stage Line Regulator or equivalent.
- Tubing with a 1/8" (.31 cm) inside diameter (I.D.) and, 1/4" (.625 cm) outside diameter (O.D.) - Vinyl tubing (VWR #63013-029), or Nalgene clear plastic tubing (Nalgene #8000-0020, VWR #63015-368)
- Y Connector, 1/8" I.D. (VWR #62850-026)

Connect these items:

- Connect the regulator to the gas source/cylinder per the regulator manufacturer's instructions.
- Use tubing to connect the outlet of the regulator to the "Y" connector.
- Connect tubing from the "Y" connector's two outlets to the fittings on the rear of the instrument.
- Check that all fittings are gas tight and secure. The valve should be turned off until the start of a test to conserve gas. Flow rates will be sufficient with the pressure set to between 4 and 5 psi.

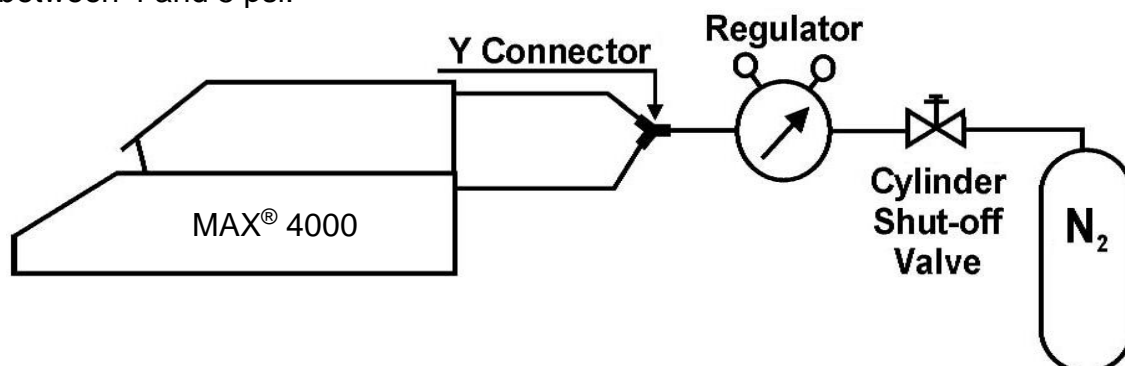

6.12. Nitrogen Control Module

The Nitrogen Control module (P/N: Y990-0214) is an optional accessory that is used in conjunction with the Nitrogen Purge Kit to conserve nitrogen. The module turns on nitrogen to the instrument prior to a test and turns off the nitrogen after a test. This is especially helpful when using a limited supply of nitrogen (bottled nitrogen). The module also monitors the nitrogen pressure and alerts the user when the nitrogen source is depleted. The incoming pressure must be between 4 and 20 psi inclusive.



The module connects to the USB Type A / Host port (marked **USB**) on the back panel.

- Unpack the module.
- Plug the Type A flat end of the included cable into the MAX[®] 4000's mating socket (marked **USB**). If other USB devices are being used, a USB hub is needed to connect multiple devices to the MAX[®] 4000. (The hub must be self-powered, i.e. use an external power adapter, or the Nitrogen Control module will not function correctly).
- Connect the Type B square end of the cable to the mating socket on the Nitrogen Control module.
- The module is enabled through the SETUP menu (See section **8.4.6 Nitrogen Control Module** on page **75**).
- When the module is connected, the module icon will appear in the bottom left corner of the main screen, above the CONTRAST soft key.



The module's flow connectors are connected into the nitrogen supply just after the regulator in the standard nitrogen purge setup.

- Connect the input to the regulator, as shown.
- Connect the output to the Y-Connector, as shown.

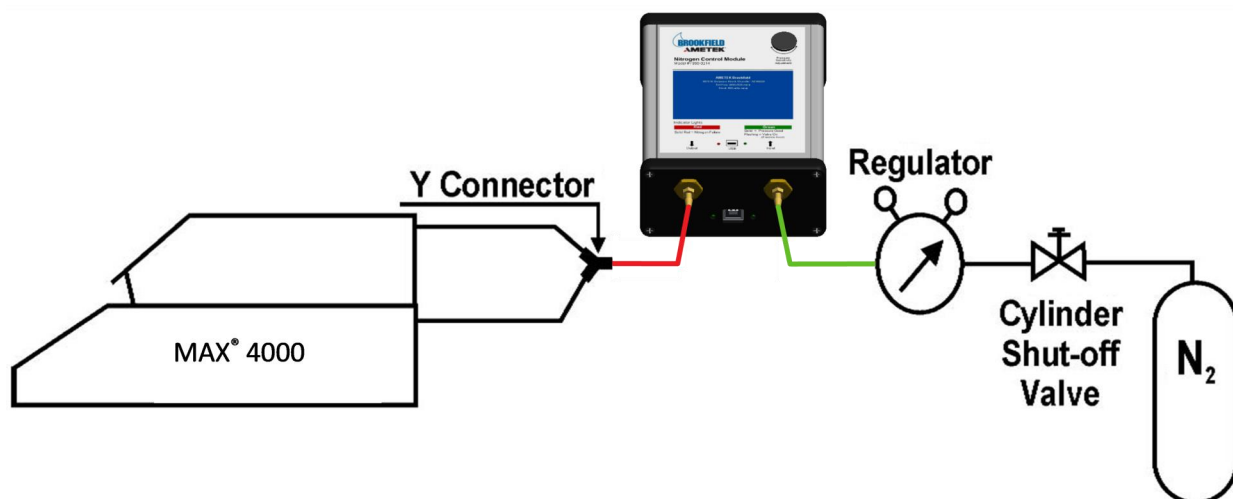

The module has two LEDs for informational purposes:

- The GREEN LED on the right:
 - Solid Green indicates good pressure and nitrogen not currently flowing.
 - Blinking Green indicates good pressure and nitrogen currently flowing.
- The RED LED on the left indicates inadequate pressure.

The trigger pressure for the module has been factory set to 3 psi +/- 0.2 psi. It takes at least this pressure to trigger a good pressure reading. If necessary, the trigger pressure can be adjusted through the capped hole on the top of the module. Once a good pressure is triggered, the pressure must drop to around 0.5 psi to trigger a low pressure reading.

To adjust:

- Set the incoming nitrogen pressure to the desired trigger pressure.
- Remove the cap from the hole on the top of the module.
- To set the module to trigger at this pressure, insert a regular screwdriver through the hole and turn the screw on the top of the pressure sensor. Turn the screw counterclockwise to lower the trigger pressure and clockwise to raise the trigger pressure. As detailed above, the LEDs indicate good and inadequate pressure. An audible click also occurs when the pressure sensor triggers.
- To verify proper adjustment, watch the LED's while disconnecting and re-connecting the nitrogen. Make fine adjustments as necessary.
- Re-install the cap into the hole.

6.13. Bar Code Reader

An optional bar code reader (P/N: GV-1412) is available from AMETEK Brookfield that allows rapid data entry. Alphanumeric data can be entered into the MAX[®] 4000 using the instrument keypad, a USB keyboard, or, if the data is in a bar code format, by using the bar code reader. When the item to be input is highlighted on the instrument, simply scan the barcode to populate the item.

For example, if the samples to be tested are labeled with bar codes, the bar code reader is useful if entering the LOT NUMBER and PRODUCT ID at the start of a test. See section **8.4.5 Misc Options** on page **74** for more information on LOT NUMBER and PRODUCT ID input.

The bar code reader connects to the USB Type A / Host port (marked **USB**) on the back panel of the MAX[®] 4000. Note, however, that the reader acts like a USB keyboard and only one keyboard device can be connected to the MAX[®] 4000 at a time. To use the bar code reader, the keyboard must first be disconnected from the instrument or USB hub, and vice versa.

- Unpack the bar code reader.
- Plug the rectangular cable end into the MAX[®] 4000's mating socket (marked **USB**). If other USB devices are being used, a USB hub is needed to connect multiple devices to the MAX[®] 4000. The hub must be self-powered i.e. use an external power adapter or the reader will not function correctly.
- When the bar code reader is connected, the keyboard icon will appear in the bottom left corner of the main screen, above the **CONTRAST** soft key.



Try out your bar
code reader here →



6.14. Installing & Removing the External Filter



Optional Filter Bracket Kit Y990-0211 required



An optional External Filter (P/N: 800-0071) is available to keep dust and other particulates from entering the interior of the instrument. If the filter is being used, it should be inspected regularly for debris build-up and replaced when dirty.

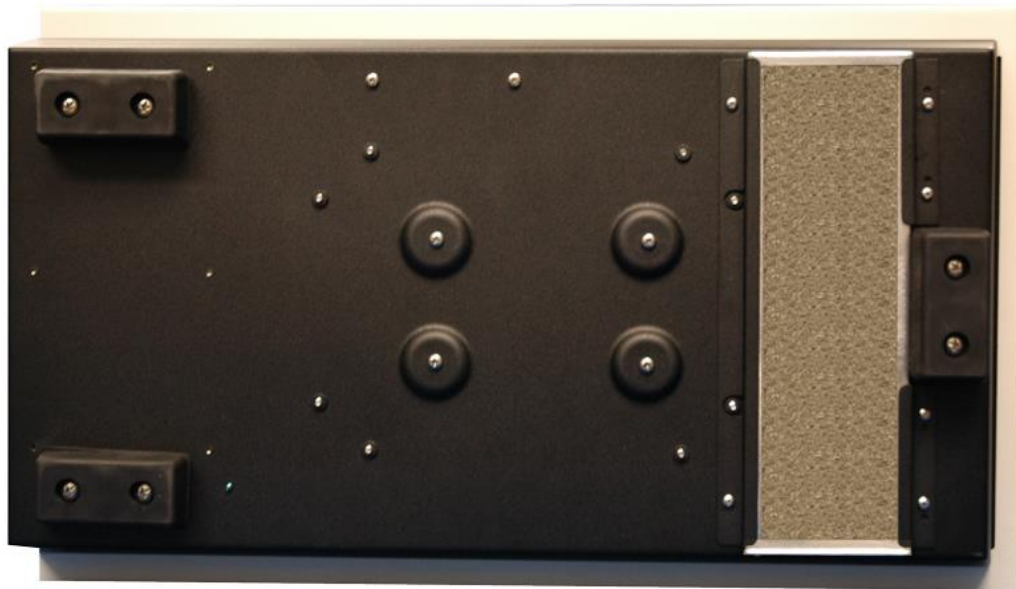

The filter can be installed and removed without placing the instrument on its side. However, if the instrument is going to be placed on its side, power off the instrument and remove the pan support first and lay down a soft cloth or piece of cardboard to avoid scratching the finish on the side of the instrument.

If the instrument is going to be laid on its side:

- Power off the instrument.
- Remove the pan support.
- Lay the instrument on its side on a piece of soft cloth or cardboard to protect the finish.
- After removal/installation is complete, set the instrument right side up before replacing the pan support and powering on the instrument.

To install the filter:

- Slide the filter into the retaining brackets with the wire lattice pattern towards the instrument as shown. Orientation is also indicated by the Air Flow arrow on the side of the filter; the arrow points towards the instrument when the filter is installed.

To remove the filter:

- Push the filter from one side and pull from the other side to remove it.
- If the filter is dirty, discard it and install a clean filter (P/N: 800-0071).

7. MOISTURE ANALYSIS TESTING

The Computrac® MAX® Series loss-on-drying moisture analysis system takes advantage of leading-edge technology to reduce test times and increase precision over standard vacuum oven or convection oven drying procedures.

Prior to testing, a Test Program is created with the parameters to be used for testing the sample. The instrument then controls the test using this Test Program, as explained in more detail in the following pages. Within each Test Program, the test temperature can be programmed between normal room temperature (25 °C) and 225 °C (275 °C on a MAX® 4000XL). Using the linked test functionality available on the MAX® 4000XL, a multi-step temperature contour can be set up across several linked Test Programs.

In the test chamber, an aluminum sample pan rests on a pan support coupled to a sensitive electronic force balance. The sample is added to the sample pan and the force balance registers the initial weight of the sample before testing. The heater located on the underside of the test chamber's lid then heats the sample, and a Resistance Temperature Device (RTD) monitors the temperature in the test chamber. The temperature readings from the RTD are sent to the microprocessor, and under the microprocessor's control, the heater element is cycled on and off to bring the test chamber to the programmed temperature.

As the sample is heated according to the Test Program selected for the test, it loses weight due to moisture evaporation. The balance records that weight loss and transmits the data to the microprocessor for evaluation. The balance readings are averaged to eliminate signal interference or erroneous data. The microprocessor interprets the information and compares the sample's weight loss to a standard drying curve. The sample's decreasing weight is compared to the initial sample weight and the calculated moisture concentration appears on the display. When using the Predict Ending Criteria, the final moisture concentration is extrapolated from the curve and results are available within minutes.

A typical drying curve is shown at the right.

Section (A-B) represents the sample's weight loss as it heats from room to testing temperature.

Section (B-C) is linear, representing moisture loss from the interior of each particle of the tested sample.

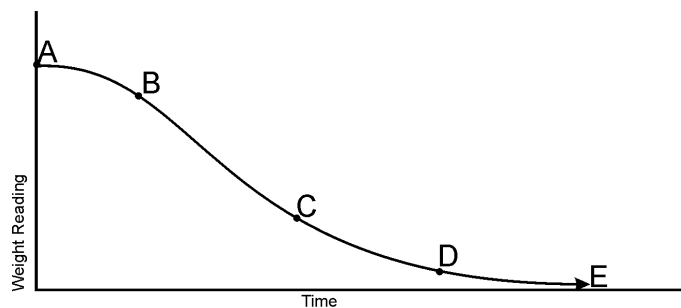

Typical Loss On Drying Curve

Section (C-D) is exponential in nature and represents the final evolution of moisture from within the particle. The point at which no additional weight loss occurs (E) represents the complete evolution of water from the original sample.

Section (D-E) is the longest and most time-consuming portion of the entire testing process. The time for a sample to reach zero residual moisture in an oven can take from one to possibly 24 hours depending upon the sample, sample preparation, and testing temperature. When using the Predict ending criteria, the MAX[®] 4000's loss-on-drying system calculates the sample's moisture concentration through mathematical extrapolation from the exponential (C-D) portion of the curve.

The microprocessor monitors the sample's weight loss during the entire testing process. Simultaneously, if using the Predict ending criteria, the microprocessor is predicting a final moisture concentration based upon the sample's rate of weight loss compared to the exponential portion of a standard drying curve. Testing continues until the predicted moisture concentration agrees within a certain percentage of the actual moisture concentration appearing on the display. The percent agreement between the predicted and the actual moisture concentrations will vary depending upon the system's programming and the moisture level of the sample.

The MAX[®] 4000 is an extremely flexible instrument. This flexibility means that some time is required to determine the best set of parameters for a particular application. The determination of the proper parameters requires a series of tests and good laboratory procedure. Call your technical salesperson for assistance developing Test Programs for your samples.

7.1. Performing a Test

A Test Program for your material must be developed prior to using the MAX[®] 4000 for production testing:

- See section **8.1 Test Programs** on page **40** for guidance setting up a Test Program. This section helps you determine the proper test temperature, ending criteria, sample size, and other parameters.
- The Parameter Expert feature (MAX[®] 4000XL only, see section **8.6 Parameter Expert** on page **79**) automatically selects most test parameters based on your reference method results and then guides you through a series of tests to determine the proper test temperature and ending criteria.
- Technical sales can develop Test Programs for your material.

After a new Test Program is developed, run 5 or more tests to obtain reliable information about the standard deviation of a typical result. Each test result is automatically saved, and the instrument can calculate the mean, standard deviation, and relative standard deviation through the Test Results menu. Note, the MAX[®] 4000 only stores 2 Test Results.

To perform a test:

- If a clean pan is not already installed, then place a new/clean sample pan on the pan support.
- Close the lid.
- If not at the Main Test screen, press **[ESC]** repeatedly until the Main Test screen is displayed.
- If the desired Test Program is not currently active, press the **[PROGRAM]** key, then highlight the desired Test Program from the list.



- If desired, press **[ENT]** to view the test parameters for the highlighted Test Program prior to starting the test. A screen similar to this one will be displayed. The test parameters cannot be edited from here, as indicated by the lock icons. Press **[ESC]** when done to return to the TEST PROGRAM SELECT screen.

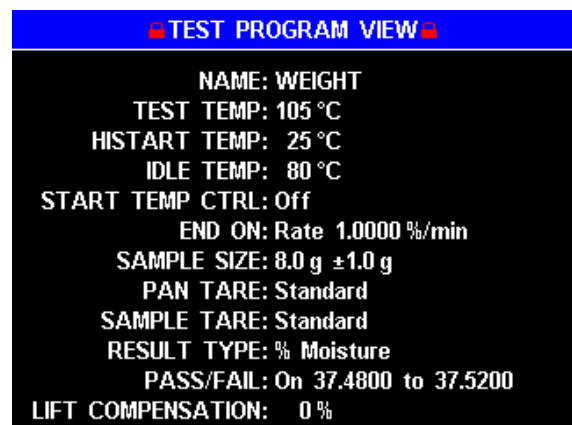

- From the TEST PROGRAM SELECT screen, press **[START]** to begin a test using the highlighted Test Program.
- The instrument will tare (zero out) the pan. This will occur instantly if the lid has been closed and the balance is stable.
- Open the lid and quickly load the sample, taking care to evenly distribute it across the entire pan surface in a thin layer to get the fastest and most accurate results.



While loading the sample, the weight is displayed graphically with the acceptable target window in green and in grams at the screen bottom. Add sample so that the sample weight is centered in the graph; an audible signal indicates when the sample weight is acceptable.

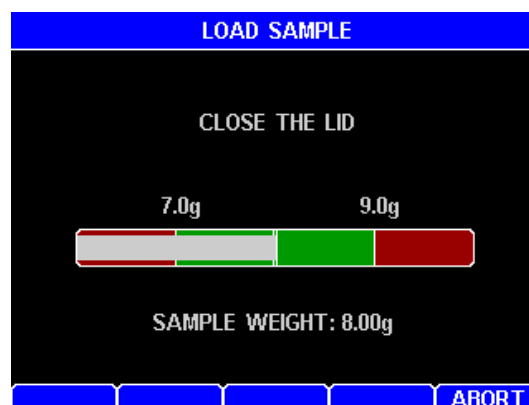

Once the desired amount has been added, the pan can be removed from the test chamber to evenly distribute the sample. The sample should be distributed over the surface of the pan by gentle shaking or tapping, or for very viscous samples, spreading with a spoon or knife. An even layer of sample across the pan will reduce test times and increase precision of results.

To load difficult samples more easily, remove the sample pan from the instrument after the correct amount of sample has been placed on the pan, place the filled pan on a level work surface, spread the sample with a small flat brush or spatula (depending on the consistency of the sample), and then replace the loaded sample pan on the pan support. Do not spread granular products with a spoon as the particles compress even under gentle pressure affecting test times and results.

Transport samples in an airtight container to prevent moisture gain or loss through contact with air.

If performing WEIGHT tests: The weight test simulates moisture loss with the removal of one of two known weights and is used to verify the balance is responding properly. Select (Factory) WEIGHT as the Test Program to perform the weight test, then wait approximately three minutes for the chamber to heat to 80 °C before starting the test. Instead of adding sample material to be tested, carefully place both the included 5-gram and 3-gram weights near the center of the sample pan when prompted.

- Close the lid, and the instrument weighs the sample.

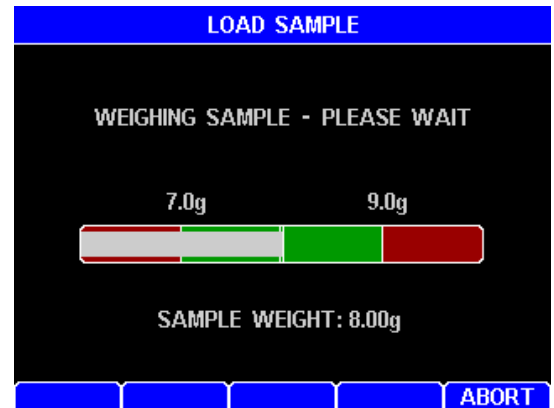

- The test proceeds to dry the sample.

For a WEIGHT test only, immediately after the instrument weighs the sample, gently open the lid, carefully remove the 3-gram weight, and gently close the lid.

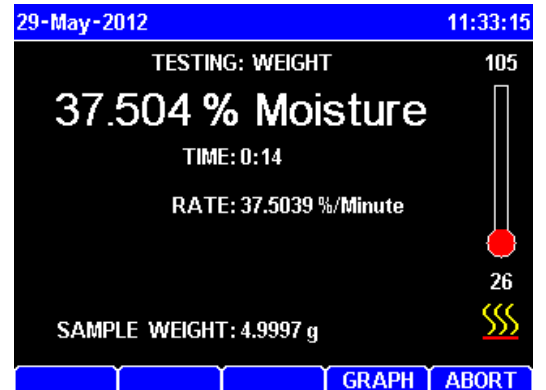

- The test finishes once the ending criteria has been met, as shown below left.

If performing WEIGHT tests: When the WEIGHT test completes, the final test result screen indicates Pass or Fail by a Green or Red background respectively and a PASS or FAIL below the result, as shown below right.

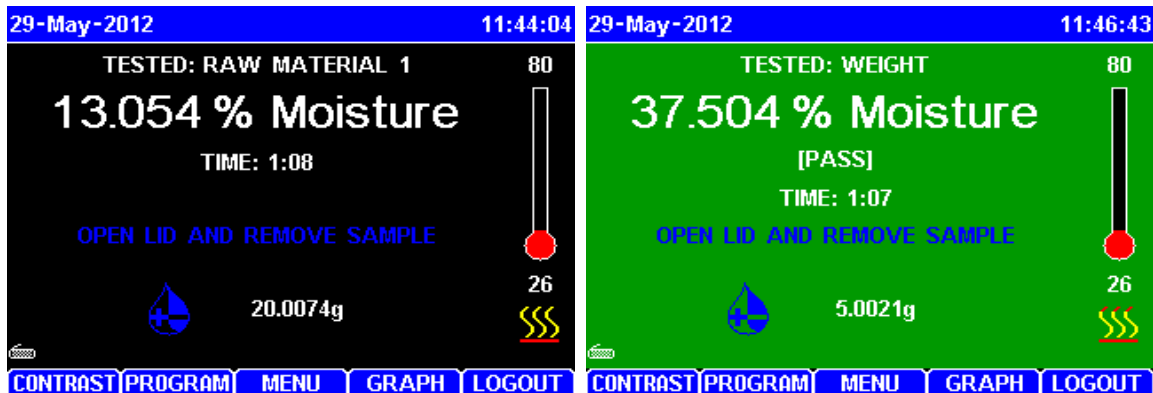

- Open the lid and remove the sample.
- Place a new/clean sample pan on the pan support to get ready for the next test.
- Close the lid when the heat chamber is cool.

7.2. Preparing Granular and Powdery Samples

The MAX[®] 4000 can be used to test a wide range of products from finely ground, low-moisture powders to high-moisture slurries. **For best results, the sample should be of a uniform particle size distributed evenly over the sample pan.** If sample material is collected into a jar or sampling bag, shake the jar or bag to produce a more thorough mixture. Note, however, if there is a large variation in particle size, shaking will tend to distribute larger particles to the top. Liquid samples should also be mixed or shaken to ensure a more homogeneous mixture. Large chunk samples, such as charcoal or cookies, should be crushed or ground to smaller pieces approximately 1/4" or less in diameter. **For best results, take care not to over-grind the sample, causing it to heat up and causing moisture loss.**

Some samples, such as dried vegetables, may also need to be ground. The smaller pieces will easily release moisture during testing, leading to shorter test times and more repeatable results. Solid, granular sample material should be shaken onto the pan from a spoon; shaking sample directly from the collection jar will usually deposit only the larger granules, not a representative mixture. Samples should be evenly distributed over the sample pan.

7.3. Preparing and Testing Liquid Samples

Some liquid samples will dry slowly, even at high temperatures. Drops or puddles may form on the pan and dry slowly as the sample concentrates. A skin may form which limits evaporation from the interior. Long test times (greater than 25 minutes) and low percent moisture (or high percent solids values) suggest incomplete drying. Pre-dried glass-fiber filter paper (P/N: 990-0003) and flat-bottomed pans (P/N: 990-0010) are recommended to successfully test samples such as these. Call AMETEK Brookfield's consumable parts sales for more information.

The glass-fiber filter paper serves as a support for the liquid sample. The sample is absorbed through the paper for more even and rapid evaporation to reduce test times. Waffle-bottom sample pans are **not** recommended for use with filter paper; the liquid sample may soak through the filter paper and collect in puddles in the pan's depressions.

Liquid samples or slurries can be spooned or poured onto the sample pan; however, a pipette or sampling straw will collect a uniform mixture of the sample. Samples should be evenly distributed over the sample pan.

Occasionally, some samples cannot be absorbed into the filter paper. At the end of the test, examination of the sample pan shows the sample sitting high above the filter paper with a thick crust. The crust may be singed from the heat or even show bubbling where vapor has been trapped beneath the surface. Percent solids results will be high, or percent moisture results will be low. Samples such as these are treated differently: After the sample has been added to the sample pan, remove the pan from the test chamber and place it onto a flat surface. Grasp part of the filter paper (tweezers are suggested) and flip it over so that the sample lies between the pan and the paper. Squash the sample with a flat-bottom glass or jar to a uniform layer. Return the sample pan to the test chamber and close the lid. The upper filter paper surface absorbs moisture from the sample and minimizes bubbling and spattering to produce more accurate, reproducible results.

8. MAIN MENU

Pressing the MENU soft key on the Main Test screen provides access to the MAX[®] 4000 menu system.

To get here, press:
[MENU]

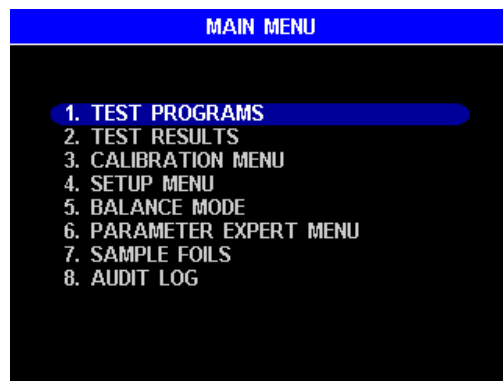

The first and second levels of the menu system are shown below and are explained in detail in this section of the manual. Throughout this section, the key presses necessary to get to the indicated menu are shown at the beginning of each subsection. Note that all menus are accessed by first pressing the MENU soft key from the Main Test screen. After making changes in the SETUP MENU, press **[ESC]** until back at the Main Menu to save the changes.

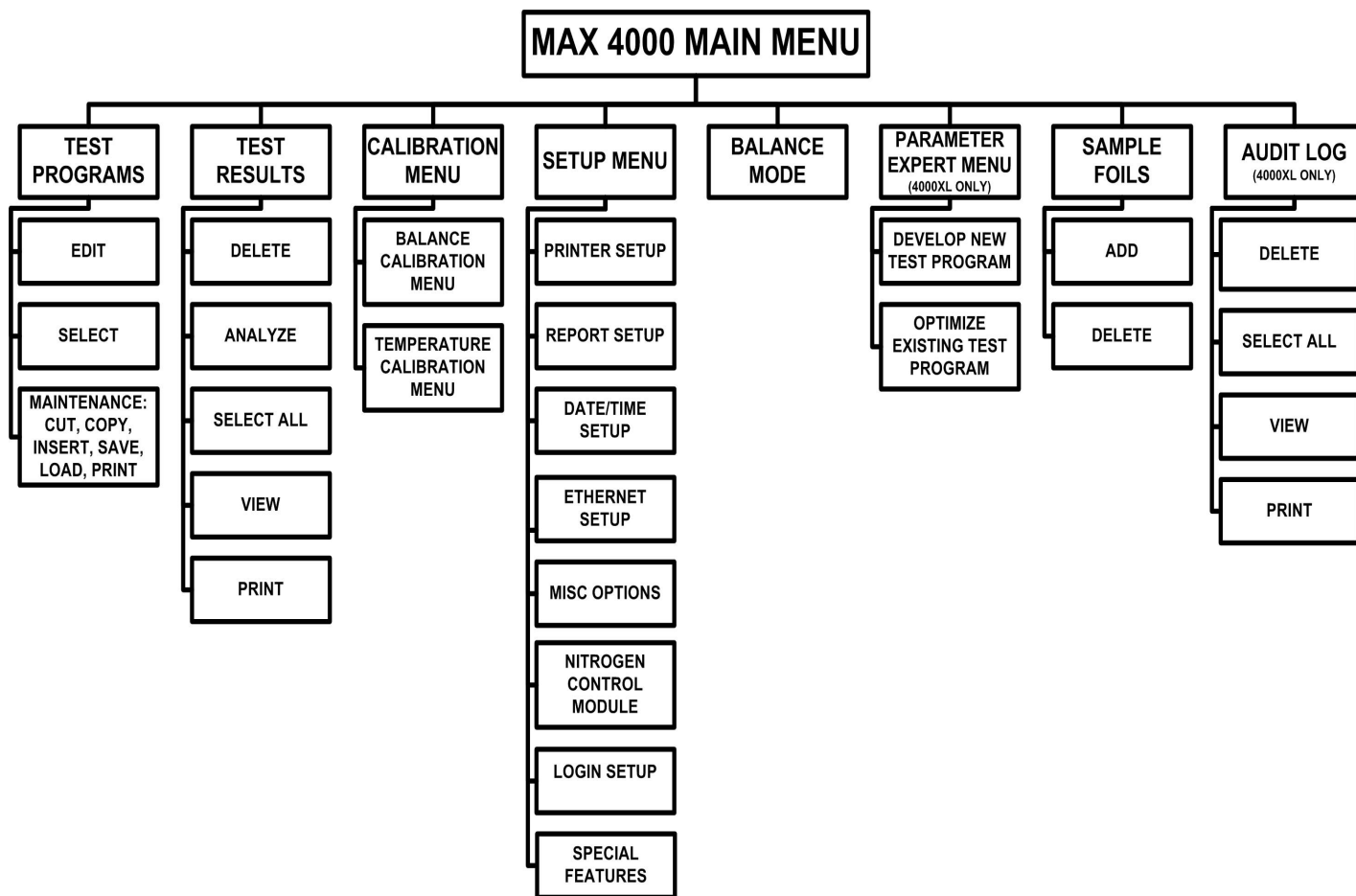

8.1. Test Programs

Test Programs are test parameter sets. They are sequentially numbered from 1 to the total number of programs entered into the instrument. The figure below shows program 1 selected, as indicated by the yellow arrow. The 1/20 in the upper right-hand corner indicates that a total of 20 test programs have been defined and the blue cursor bar is on number 1 out of 20. The “(Factory)” programs are for standard tests to check the performance of the instrument. The MAX[®] 4000XL has 245 user programs and 5 factory programs, while the MAX[®] 4000 only has 6 user programs and 4 factory programs. (The (Factory) DRIFT test is only available on the MAX[®] 4000XL.)

To get here, navigate:

[MENU]→TEST PROGRAMS

TEST PROGRAMS allows access to the test parameter sets. This is where the contents of the Test Programs may be printed or changed.

The keypad functions are:

- **Up and Down Arrow Keys** move the cursor one line at a time.
- **Left and Right Arrow Keys** move the cursor one page at a time.
- **[START]** key selects the highlighted Test Program and immediately begins a test.
- **[ENT]** – Select and edit the highlighted Test Program. Press **[ESC]** when done to return to the TEST PROGRAM EDIT screen. This program will now be selected.
- **[CUT]** – Copy the current program into temporary memory and delete it from the list. The program can be optionally inserted at another location. **Use this carefully.** The “(Factory)” programs cannot be deleted with this option.
- **[COPY]** – Copy the current program into temporary memory, which can be optionally inserted at another location.
- **[INSERT↑]** or **[INSERT↓]** - Insert the program that is in temporary memory into the list either above or below the current program. The following programs are moved down, and multiple copies can be made with multiple insertions.
- **[I/O]** – Displays the **[SAVE]**, **[LOAD]**, **[PRINT]**, and **[MOVE]** soft keys. These soft keys are used to upload, download or print Test Programs, as shown on the next page.

To add a new Test Program:

- Highlight an existing Test Program and press **[COPY]**,
- Use the arrow keys to scroll to the desired location in the list for the new program,
- Press one of the insert keys to insert a copy of the Test Program.
- Edit the inserted Test Program to reflect the desired parameters, as explained in the following pages.

When the MAX[®] 4000 is powered on, it will immediately begin heating to the IDLE TEMPERATURE of the first Test Program in the list. When shipping from the factory, the default first Test Program in the list is the (Factory) IDLE Test Program, which has an IDLE TEMPERATURE of room temperature (25 °C) to avoid undesired heating. To change the default Test Program upon power up, insert the desired Test Program at position 1 in the list of Test Programs.



The following soft keys are available after pressing the I/O soft key on the TEST PROGRAM EDIT screen:

- **[SAVE]** – Save a copy of any or all of the Test Programs to a USB drive. After pressing **[SAVE]**, follow the onscreen instructions to plug in a USB drive, select the desired programs and save them to the USB drive.



- **[LOAD]** – Load the Test Programs saved on a USB drive into the MAX[®] 4000. After pressing **[LOAD]**, follow the onscreen instructions to plug in a USB drive and select where in the list of Test Programs the new ones should be loaded. The Test Programs will be loaded starting below the selected location.
- **[PRINT]** – If a printer is connected, **[PRINT]** is used to print a summary of the stored Test Programs. An explanation of the column headings and an example print-out are shown below. The “(Factory)” programs do not print.
- **[MOVE]** – Changes the soft keys back to **[CUT]**, **[COPY]**, **[INSERT↑]**, **[INSERT↓]**, and **[I/O]**, as shown on the previous page.
- Refer to **APPENDIX A: SAVING & LOADING TEST PROGRAMS** for step-by-step guidance on saving and loading Test Programs with a USB drive.

The TEST PROGRAM REPORT column headings are abbreviations for the following:

#	Number of the Test Program
ID	Name of the Test Program
TST	Test Temperature
IDL	Idle Temperature
HST	High Start Temperature
SSZ	Sample Size
SWN	Sample Window
LFT	Lift compensation amount
LINK	Indicates if this Test Program is linked to the next one (MAX [®] 4000XL)
EC MODE	Ending Criteria

COMPUTRAC MAX 4000 TEST PROGRAM REPORT									
COMPANY: PREFERRED CUSTOMER							INSTRUMENT #: 400000		
#	ID	TST	IDL	HST	SSZ	SWN	LFT	LINK	EC MODE
5	Program 5	160	25	25	8.0	1.0	100	No	Rate 0.1000%/min
6	Program 6	160	25	25	8.0	1.0	100	No	Rate 0.1000%/min
7	Program 7	160	25	25	8.0	1.0	100	No	Rate 0.1000%/min
8	Program 8	160	25	25	8.0	1.0	100	No	Rate 0.1000%/min
9	Program 9	160	25	25	8.0	1.0	100	No	Rate 0.1000%/min
10	Program 10	160	25	25	8.0	1.0	100	No	Rate 0.1000%/min
11	Program 11	160	25	25	8.0	1.0	100	No	Rate 0.1000%/min
12	Program 12	160	25	25	8.0	1.0	100	No	Rate 0.1000%/min
13	Program 13	160	25	25	8.0	1.0	100	No	Rate 0.1000%/min
14	Program 14	160	25	25	8.0	1.0	100	No	Rate 0.1000%/min
15	Program 15	160	25	25	8.0	1.0	100	No	Rate 0.1000%/min
16	Program 16	160	25	25	8.0	1.0	100	No	Rate 0.1000%/min
17	Program 17	160	25	25	8.0	1.0	100	No	Rate 0.1000%/min
18	Program 18	160	25	25	8.0	1.0	100	No	Rate 0.1000%/min
19	Program 19	160	25	25	8.0	1.0	100	No	Rate 0.1000%/min

A Test Program may be edited by moving the cursor to the desired program and pressing the **[ENT]** key.

There are 8 categories of test parameters for each Test Program, as shown, each explained in more detail in the following pages.

Refer to section **6.4 User Interface Operation** on page **18** for instructions on how to edit items.

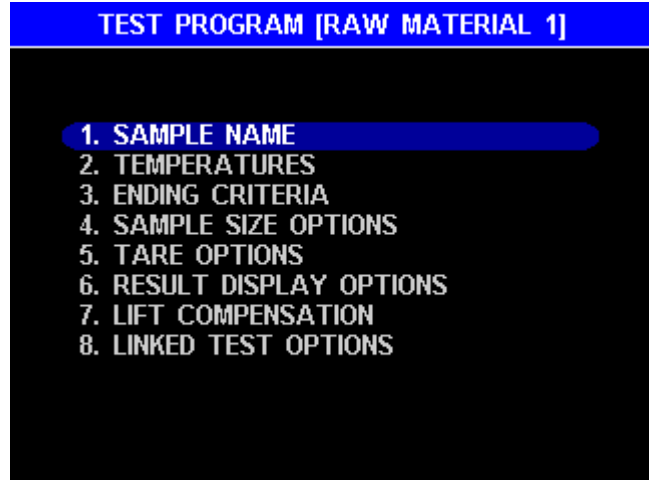

8.1.1 Sample Name

To get here, navigate:
[MENU]→TEST PROGRAMS→**[ENT]** to edit a program→SAMPLE NAME

Use any name or number to identify the product under test.

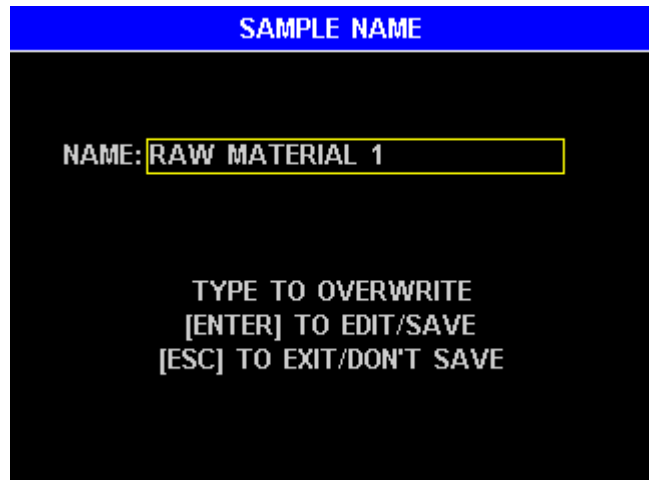

8.1.2 Temperatures

The temperature parameters control the test result, speed, and repeatability.

If the moisture of the sample material is known, as determined by a reference method, the MAX[®] 4000's temperature can be adjusted until test results correlate with the established moisture concentration. If the moisture is not known, prepare a moisture versus temperature curve to decide the proper test temperature for a particular sample.

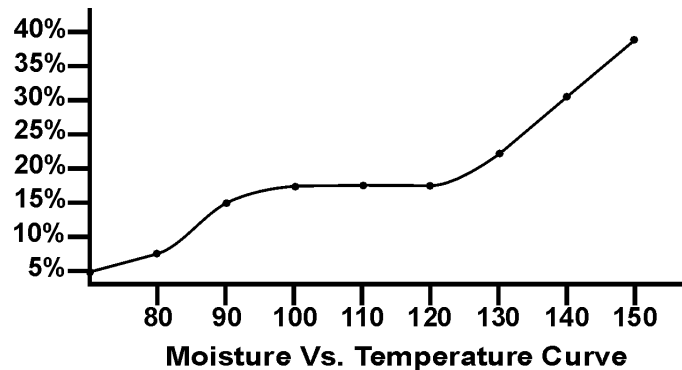

An appropriate curve can be prepared by running multiple tests of the sample material at temperatures increasing in five-degree increments.

The starting temperature is usually the standard or reference method temperature for the particular sample. Results for each increasing temperature will usually rise to a plateau where several temperature increases do not change the results significantly. Beyond this plateau, results can rise dramatically. A sample tested at these increased temperatures may show burning or charring.

Results along the plateau usually correlate well with the standard or reference method results. Repeated testing should be done at temperatures in this range. Several tests are performed using the same sample size and test parameters. Results from these repeated tests are tabulated to calculate the mean, or average, and the standard deviation (S.D.). Analysis of the mean and standard deviation, and their comparison with reference method results, determines if the proper test temperature has been used. If mean values do not compare well, or if the standard deviation is too large, test at another temperature along the plateau. Higher temperatures generally result in faster test times and less repeatability.

To get here, navigate:

[MENU]→TEST PROGRAMS→[ENT] to edit a program→TEMPERATURES

The following options are available:

- TEST TEMPERATURE – Set to a value that correlates well to the reference method and gives good test times and repeatability. The maximum test temperature is 225 °C on the MAX[®] 4000 and 275 °C on the MAX[®] 4000XL.

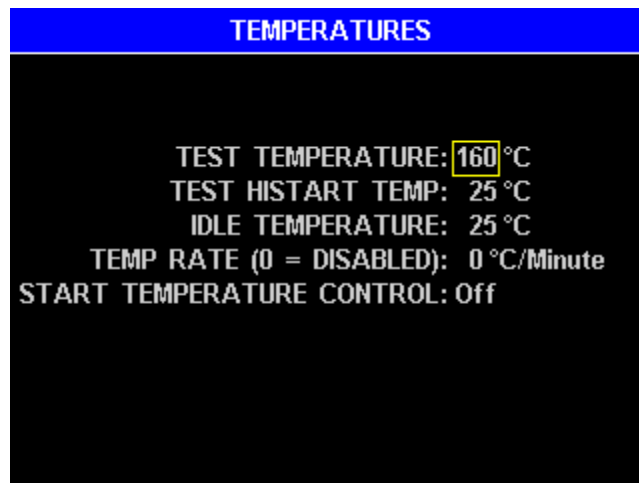

- TEST HISTART TEMP - When active, the HISTART TEMP is used at the start of the test, and the test continues at that temperature for at least one minute. When the rate of moisture loss falls to half of its peak value, the instrument then changes to the TEST TEMP for the remainder of the test. This shortens a long test without affecting the results and may be useful for tests longer than 15 minutes. When used, try a HISTART TEMP that is 25 °C above the TEST TEMP. To deactivate the HISTART feature, set the HISTART TEMP to 25 °C.
- IDLE TEMPERATURE – This is the temperature that is maintained by the instrument between tests. This speeds testing throughput by decreasing the time required to heat the sample chamber at the beginning of the test and reducing the cool down time between tests. An appropriate idle temperature can save 10 to 120 seconds of test time and several minutes of cool down time if properly used. A common idle temperature value is 50 °C or 80 °C for most products. For plastics, a 100 °C idle is desirable. Any value between 25 °C and 150 °C can be used. Too high a value causes low results because the sample is evaporating while the starting weight is being measured at the beginning of the test. Experiment to see what value is best for your application.
- TEMP RATE - The temperature is controlled to the specified rate while ramping to the setpoint. This can be used to slow the heating of a sample to determine at what temperature the sample releases volatiles. The Temp Rate can be set from 1 to 99 °C per minute and has a range of control from 40 to 275 °C. During the ramp, temperatures are maintained to within 1% of the instantaneous temperature determined by the temp ramp rate. Set TEMP RATE to 0 to disable temperature ramp control. Note: only the MAX[®] 4000XL has Temp Rate Control.
- START TEMPERATURE CONTROL - Prevents a test from starting if the chamber temperature is more than five degrees hotter or colder than the IDLE TEMPERATURE. Once the temperature has stabilized at the IDLE TEMPERATURE, the instrument will allow the test to be started. This feature can improve the standard deviation of results of some temperature-sensitive materials.

8.1.3 Ending Criteria

To get here, navigate:

[MENU]→TEST PROGRAMS→**[ENT]** to edit a program→ENDING CRITERIA

The ending criterion is used by the instrument to automatically end a test. This feature makes it unnecessary for the operator to monitor the instrument while it is performing a test. All ending criteria are available on the MAX[®] 4000XL, but only PREDICTION and RATE are available on the MAX[®] 4000.

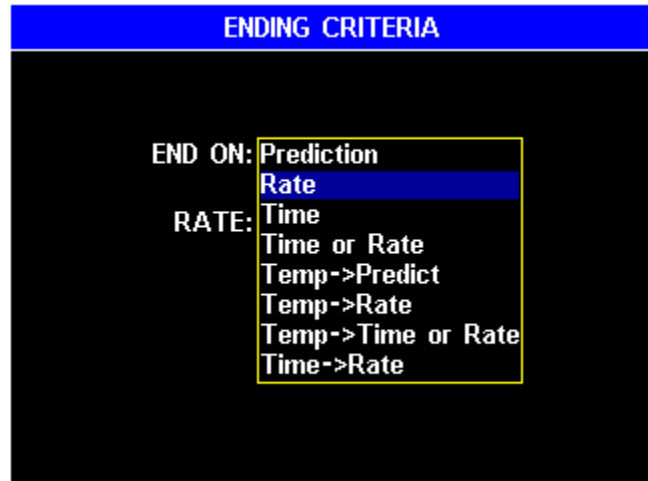

The decision of which ending criterion to use is application dependent. Best results are typically given with PREDICTION or RATE, rather than TIME. Experiment with your particular sample to determine which criterion is best for your product.

For PREDICTION, the MAX[®] 4000 predicts what the final result should be by extrapolating the current moisture loss curve. Prediction begins about a minute after peak rate loss. The test ends when the actual moisture loss is within X% of the predicted value, where X is typically 90; this is the “reliability” value listed in the Test Results. Prediction can reduce test times by 1 to 5 minutes. Set X to a higher value if 90 is not producing good results. If the moisture loss curve shape does not fit the Prediction model, then it will produce poor results; Prediction does not work on all samples.

For RATE, the MAX[®] 4000 ends the test after the sample weight loss rate has fallen below a preset value. This is the most common ending criteria and works well with samples that show a consistent moisture rate loss at some point in the process. The parameter may be set for values from 0.0010% to 9.9999% loss rate on the MAX[®] 4000XL. (0.01% to 9.99% on the MAX[®] 4000). A good value to use is the (Expected Moisture Result) / 30, but do not use a value outside the range 0.0050% to 0.5%. For example, if the Expected Moisture Result is 3.00%, then use a Rate EC of 0.100%/minute. Note: A test with a RATE ending criteria will always last at least one minute, however, the test will end in 4 minutes if a peak rate of at least 0.0010% is not detected.

The MAX[®] 4000 assumes that the sample contains volatile material that will completely evaporate after some time. It further assumes that the rate of moisture loss (or weight change) will increase to a maximum point and then gradually decrease to zero. Selecting some threshold rate values will cause the test to end before the sample is completely dry. Rate is useful to profile a sample's weight loss. Some testing applications are faster using the rate ending criteria, while others are faster using the prediction ending criteria.

Some samples contain more than one volatile material, such as nylon resins with large amounts of unpolymerized material (Caprolactam). In these cases, the rate will fall to some fixed value when all the moisture has evaporated but while the monomer is still evaporating. The GRAPH display available from the Main Test screen is of great help in visualizing these cases. The rate ending criteria, if set above the rate of monomer volatilization, may give the best results.

For TIME, the MAX[®] 4000XL ends the test after a preset time (up to 120 minutes) has past. TIME may be useful for conducting sample characterization tests and other development purposes.

For TIME or RATE, the MAX[®] 4000XL ends the test after the sample weight loss rate has fallen below a preset value or after a preset time. The TIME or RATE may be useful to quickly end a test for a sample that is much wetter than expected and the final result is not necessary.

Use the “TEMP THEN ...” ending criteria (TEMP→PREDICT, TEMP→RATE, and TEMP→TIME OR RATE) to prevent a test from ending before the temperature reaches within 2 degrees of the preset test temperature. Generally, this is not needed.

Use the “TIME THEN RATE” ending criteria (TIME→RATE) to end the test when the sample weight loss rate falls below the preset value, after the set time has elapsed. This ending criterion is useful for:

- Samples that take a long time to heat up before evolving moisture (the rate curve stays low for a while before rising significantly).
- Samples that have a double peak evolution rate curve. Use the Time set to extend the test past the first evolution rate peak.

The MAX[®] 4000 will end a test after 120 minutes regardless of the selected ending criteria.

8.1.4 Sample Size Options

To get here, navigate:

[MENU]→TEST PROGRAMS→**[ENT]** to edit a program→SAMPLE SIZE OPTIONS

The sample size options are used during sample loading to restrict the sample load to a desirable amount. Sample sizes can be programmed from 0.2g to 39.9g. The sample window must be at least ± 0.1 g and the total of the sample size plus the sample window must be less than or equal to 40g maximum. Note: Samples as small as 100mg (or as large as 40g) can be tested by using a sample size of 0.2g (or 39.9g) with a sample window of 0.1g.

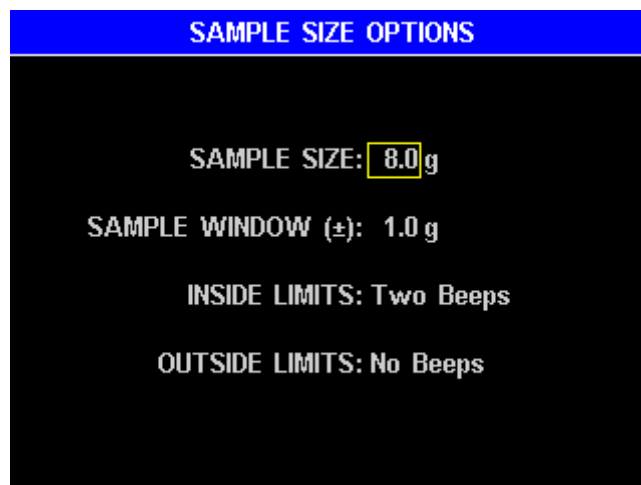

The available options are:

- **SAMPLE SIZE** – Set as discussed above.
- **SAMPLE WINDOW** – Set the allowable sample size tolerance. A smaller tolerance produces more repeatable results but makes it more difficult to load a sample. Generally, pick a window size $\leq 10\%$ of **SAMPLE SIZE** and less than 1g.
- **INSIDE LIMITS AND OUTSIDE LIMITS** - Selections of no sound, one beep, two beeps or three beeps may be programmed to have the instrument indicate when the weight of the sample is inside or outside the sample weight tolerance.

Each particular sample will have its own optimum sample size. Best results will be obtained if the sample consists of a single layer of particles, as long as this is sufficient to develop a weight loss of 10 milligrams or more. A good rule of thumb is "the lower the moisture, the larger the sample."

A larger absolute weight change between the initial and final sample weights gives more accurate, repeatable results, but a smaller sample size gives faster tests. Generally, it is best to use a thin layer of sample that just covers the surface of the pan. Very light, or very expensive, test materials may necessitate weighing as little as 150 milligrams. (With a sample size of 0.2g and a sample window of 0.1g, samples as small as 0.1g can be tested.) Note, however, that the standard error will be larger for samples this small, unless the moisture content is sufficient to cause a weight change of at least 10 milligrams for each test. If the first result is too low, increase the sample size or raise the temperature. If it is too high, decrease the sample size or lower the temperature.

General recommended sample sizes are as follows:

- High volatile materials, such as coatings, typically require a smaller 1 to 3g sample. Larger samples can be used to increase accuracy, but test times will increase.
- Materials that are 2% to 98% moisture typically require around a 5g sample.
- Low moisture materials ($< 2\%$) require around a 10g sample.
- Ultra-low moisture materials ($< 0.1\%$), such as plastic resins, typically require larger sample sizes. The instrument is optimized for ultra-low moisture testing with a 30g sample size.

Contact your technical salesperson for assistance with appropriate sample sizes.

8.1.5 Tare Options

To get here, navigate:

[MENU]→TEST PROGRAMS→[ENT] to edit a program→TARE OPTIONS

The following options are available:

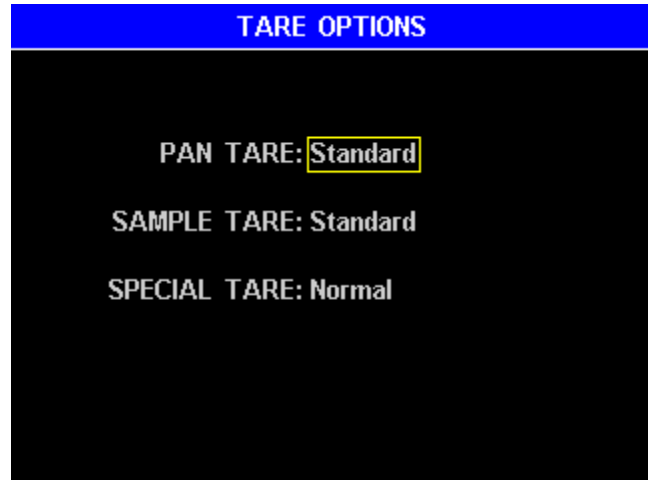

- PAN TARE records the empty pan weight after ensuring that its weight is sufficiently stable over a programmable period of time. Pan Tare continues until the weight is found stable ($\leq 0.2\text{mg}$ deviation) over the programmable period of time. Temperature fluctuations occur in the test chamber, dependent on a number of different criteria such as previous test temperature, the amount of cool down time between tests, and the current idle temperature. The temperature fluctuations cause the balance readings to drift and are reflected as an error in the result. Because the conditions that cause the temperature fluctuations are not always constant, the error often appears as a higher standard deviation on higher moisture samples. Obtaining an accurate Pan Tare is crucial for low moisture samples.

If the lid has been closed prior to starting the test and the balance is near zero (-0.1 to 0.1g), then Pan Tare usually occurs instantly unless something has recently upset the balance readings.

The following options are available:

- o Standard is good for most materials.
- o Extended may improve results for low moisture materials.

- **SAMPLE TARE** waits a fixed time after lid closure and records the starting sample weight. Obtaining an accurate Sample Tare is crucial for low moisture samples.

The following options are available:

- High Volatile is used for high volatile materials that evaporate during the Sample Tare. During the Sample Tare, the rate of evaporation is measured, the rate is used to calculate the amount that has evaporated during the tare, and the amount is added back into the starting weight to produce a more accurate Sample Tare.
 - Standard is used for most samples.
 - Ultra-Low Moisture can be used for samples with < 0.1% moisture.
- **SPECIAL TARE** options are:
 - Normal Tare is used for most samples.
 - Syringe Tare is used to obtain an accurate sample tare for materials that rapidly evaporate during the sample loading process. To use this feature, an external balance with 0.0001 gram (0.1 mg) resolution is required. Typically, the test process is as follows:
 - Load the syringe with the sample and place it on the external balance.
 - Tare the balance to zero out the weight of the loaded syringe.
 - Start a test with the desired Test Program that uses Syringe Tare.
 - When prompted to load the sample, discharge the sample onto the sample pan from the syringe.
 - While the test is running, reweigh the syringe on the external balance. The displayed value will correspond to the initial sample weight, but it will be negative (due to the taring of the loaded syringe).
 - When the test completes, the instrument will prompt for the initial weight of the sample. Drop the negative sign and input the value from the previous step.
 - The instrument will then use the manually entered sample weight to compute the results, eliminating any discrepancy due to sample evaporation during the loading process.Syringe Tare Test Programs cannot be linked with other Test Programs.
 - Foil Tare is used when a sample of sprayed material, such as paint, is to be tested. Up to 50 pieces of foil can be pre-weighed and stored before the sample is applied. At the start of a test, the user selects a Sample Foil from a list of stored foils. The weight of the foil is subtracted from the measured weight, giving the true weight of the sprayed sample. See section **8.7 Sample Foils** on page **84** for more information.

8.1.6 Result Display Options

To get here, navigate:

[MENU] → TEST PROGRAMS → [ENT] to edit a program → RESULT DISPLAY OPTIONS

Standard or custom equations can be employed by the instrument to calculate results. Custom equations are usually used in linked tests (available only on the MAX[®] 4000XL) and other tests where industry specific calculations are needed. Additionally, a secondary result that uses a custom equation can be performed in case two result types are desired.

The following options are available:

- PRIMARY RESULT options are:
 - % Moisture results are displayed as the percentage of weight lost.
 - % Solids results are displayed as the percentage of weight remaining.
 - % Dry Weight results are displayed on a dry weight basis.
 - Custom EQ results are calculated from a custom user equation. Once selected, use the [EDIT EQ1] soft key to enter the equation for the custom Primary result or the [EDIT EQ2] soft key to enter the equation for the custom Secondary result. Only the MAX[®] 4000XL has Custom Equations.

Enter the unit NAME for the custom equation.

Next, enter the equation (EQ). As the custom equation is entered, the item turns red when the equation is incomplete or invalid to prevent an invalid equation from being used. Select symbols by using the **Arrow** keys on the keypad and pressing [ENT]. (The soft key arrows move through the equation itself). Press the [SAVE] soft key when equation is complete and then move the cursor to K1 and/or K2 to enter their values if needed. Press [ESC] to return to the previous screen when finished.

The following symbols are available:

- K1 & K2 are user definable constants.
- WI is the initial weight of the current test.
- WF is the final weight of the current test.
- WI1 is the initial weight of the 1st test in a linked series.
- WF1 is the final weight of the 1st test in a linked series.
- WF2 is the final weight of the 2nd test in a linked series.
- WF3 is the final weight of the 3rd test in a linked series.

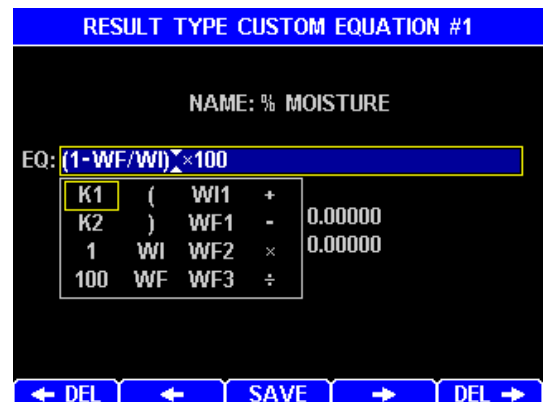
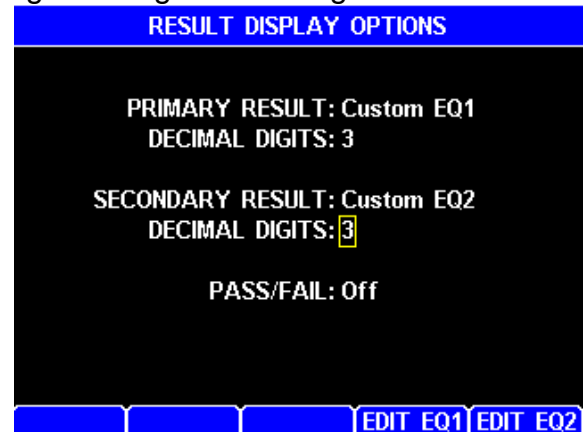
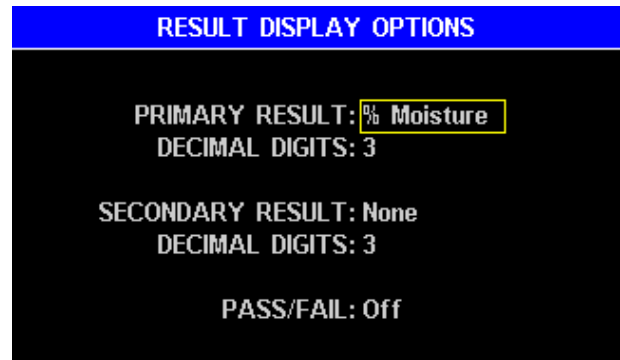

Standard algebraic rules for order of operations are used, so multiplication and division are performed prior to addition and subtraction. Use parentheses to override algebraic precedence.

Examples of normal tests:

- % Moisture = $(1 - W_{\text{FINAL}} / W_{\text{INITIAL}}) * 100$.
- % Solids = $W_{\text{FINAL}} / W_{\text{INITIAL}} * 100$.
- % Dry Weight = $(W_{\text{INITIAL}} - W_{\text{FINAL}}) / W_{\text{FINAL}} * 100$

Examples of linked tests:

- % Moisture of the 2nd test in a linked series based on the original starting weight has an equation of $(1 - WF / WI1) * 100$.
- % Solids of the 3rd test in a linked series based on the original starting weight has an equation of $WF / WI1 * 100$.

See section **8.1.8 Linked Test Options** on page **53** for more information on linking tests.

- DECIMAL DIGITS specify the number of decimal positions to display after the decimal point. For standard result types, a selection of 3 to 4 decimal digits is typical. The MAX[®] 4000XL can be set to display from 1 to 5 decimal digits, while the MAX[®] 4000 has a fixed 2 decimal digit result.
- SECONDARY RESULT (MAX[®] 4000XL only) – Enabling SECONDARY RESULT will display a 2nd result value in addition to the PRIMARY RESULT. The SECONDARY RESULT is always determined by a user created custom equation. Refer to the PRIMARY RESULT options starting on the previous page for assistance creating custom equations.
- PASS/FAIL – When enabled, the PRIMARY RESULT is compared to the LOW/HIGH LIMITS. If the result is within the limits, then the result passes. The final test result screen indicates Pass or Fail by a Green or Red background respectively and a PASS or FAIL below the result. The TEST RESULTS list also indicates Pass or Fail by using Green or Red text respectively for the result. When entering the LOW/HIGH LIMITS, the HIGH limit must be entered first, and the LOW limit must be between zero and the HIGH limit.

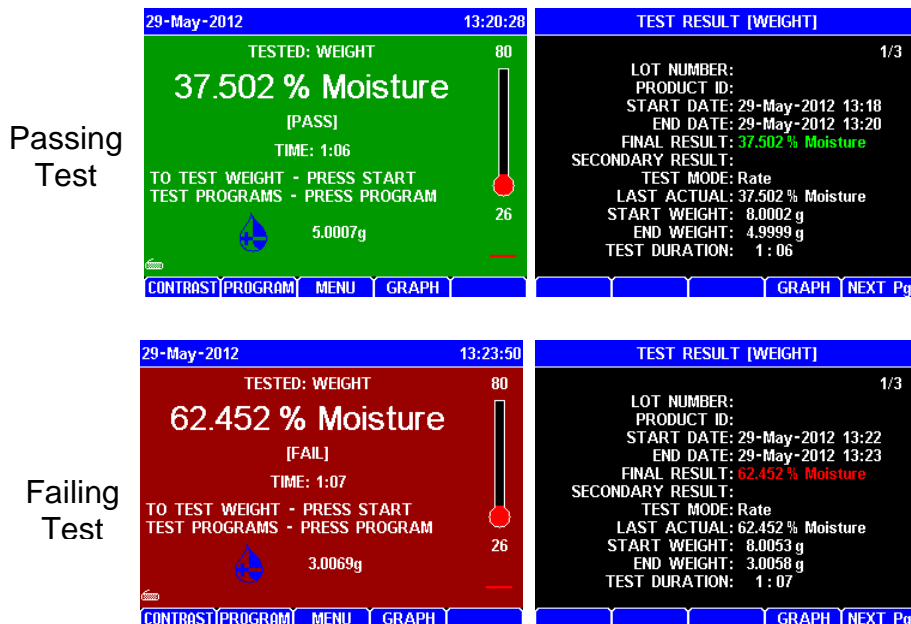

TEST RESULTS			
			3/17
1. WEIGHT	29-May-2012	62.452	
2. WEIGHT	29-May-2012	37.502	
3. COMPOUND X	29-May-2012	12.809	
4. COMPOUND X	29-May-2012	12.814	
5. COMPOUND X	29-May-2012	12.809	
6. COMPOUND X	29-May-2012	12.818	
7. COMPOUND X	25-May-2012	12.811	
8. RAW MATERIAL 1	25-May-2012	13.055	
9. RAW MATERIAL 1	25-May-2012	13.055	
10. RAW MATERIAL 1	25-May-2012	13.055	

Test Results Screen

8.1.7 Lift Compensation

To get here, navigate:

[MENU]→TEST PROGRAMS→[ENT] to edit a program→LIFT COMPENSATION

Programmable lift compensation is a feature found only in Computrac® instruments. It is included because of heated air currents in the oven chamber that apply lift to the sample pan. This causes a falsely high apparent weight loss. If not compensated, this error leads to erroneously high moisture values. The amount of lift generated by the hot sample varies from sample to sample and increases with the test temperature.

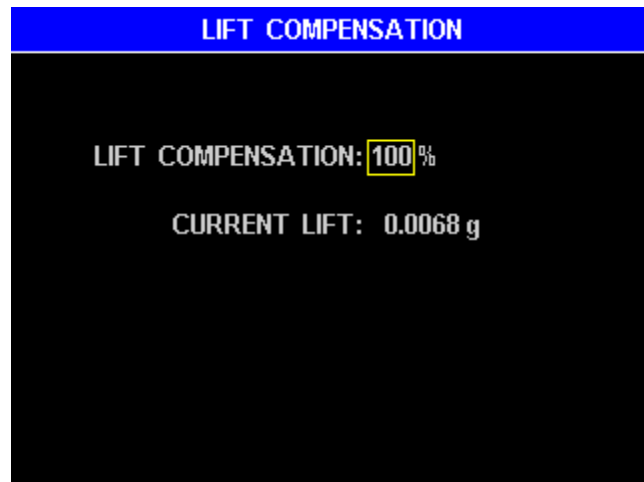

In some cases, the lift is approximately 10 milligrams and is small enough that less sensitive instruments do not provide compensation. Because the MAX® 4000 can sense a weight change as small as 0.1 milligrams, the lift must be compensated when the lift value is a significant portion of the total weight change during a test.

For example, some plastic resins are controlled to a moisture content of 0.01%, so for a 30-gram sample, the weight change is only 3 milligrams. Similarly, some lyophilized drugs are so valuable that the sample weighs only 150 milligrams. At 2% moisture, the weight change is only 3 milligrams.

The MAX® 4000 automatic lift compensation factor is determined at the factory. Each instrument is characterized for lift produced under standard conditions, and for the way that lift changes for various test temperatures. The factor is called the 100% lift compensation value. Each sample material has a degree of similarity to the maximum lift sample, and this is expressed as a percentage of the maximum lift. This value is entered under LIFT COMPENSATION. **Use 100% for all samples unless it is found by experiment that another value is more appropriate.** Contact your technical salesperson for help in determining the proper value for difficult applications.

8.1.8 Linked Test Options

To get here, navigate:

[MENU]→TEST PROGRAMS→[ENT] to edit a program→LINKED TEST OPTIONS

Linking Test Programs enables multiple adjoining programs to run sequentially as one test, changing temperatures, ending criteria, times, etc. between test segments. This feature is only available on the MAX[®] 4000XL.

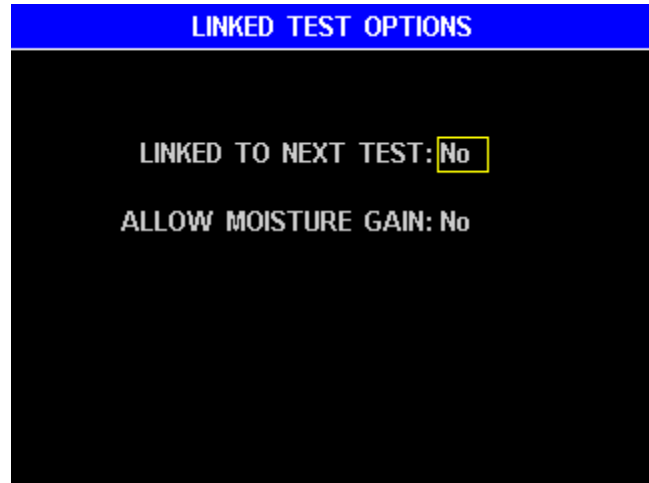

In some materials, such as gypsum powder, moisture occurs in more than one molecular state, usually free water and one or two bound water states. By linking tests with different parameters, all of the moisture can be released and measured in its various forms. Since the instrument's lid is not opened between tests, rehydration is prevented. As the test for free moisture is completed, the next Test Program in the sequence is initiated. This subsequent Test Program must contain the parameters for the bound water test. As this test ends, the next Test Program is initiated and so on, up to 4 programs total. Tests that utilize Syringe Tare cannot be linked together. Results from linked tests are displayed on the MULTIPLE TEST VIEW screen, as shown here, using gypsum as an example.

For example, for gypsum:

- Free water evaporates from the sample at relatively low temperatures, typically 40 °C to 80 °C.
- Bound water however requires higher temperatures, some around 135 °C and others around 240 °C to break the molecular bonds.



Linked Test Programs after the 1st program typically use custom result equations (See section **8.1.6 Result Display Options** on page 50).

Sometimes a material may be dried prior to testing, and the material may actually gain moisture during the test. ALLOW MOISTURE GAIN allows the instrument to report negative results. In this case, a Rate ending criteria will end in 4 minutes if a peak loss rate is not detected. The “Rate or Time” ending criteria can be used to end the test sooner.

8.2. Test Results

To get here, navigate:
[MENU]→TEST RESULTS

The TEST RESULTS item allows access to past Test Results. On the MAX[®] 4000XL, up to 1,000 results and 100 graphs can be stored before the oldest is overwritten. The MAX[®] 4000 only stores 2 Test Results and has no Test Graphs.

The keypad functions are:

- **Up and Down Arrow Keys** move the cursor one line at a time.
- **Left and Right Arrow Keys** move the cursor one page at a time.

TEST RESULTS			
			1/15
1.	COMPOUND X	29-May-2012	12.809
2.	COMPOUND X	29-May-2012	12.814
3.	COMPOUND X	29-May-2012	12.809
4.	COMPOUND X	29-May-2012	12.818
5.	COMPOUND X	25-May-2012	12.811
6.	RAW MATERIAL 1	25-May-2012	13.055
7.	RAW MATERIAL 1	25-May-2012	13.055
8.	RAW MATERIAL 1	25-May-2012	13.055
9.	RAW MATERIAL 1	25-May-2012	13.054
10.	RAW MATERIAL 1	25-May-2012	13.056
DELETE ANALYZE SEL ALL VIEW PRINT			

- **[ENT]** – Select the result currently highlighted by the cursor. Multiple results can be selected by scrolling to the next desired result and pressing **[ENT]** again. Press **[ENT]** again to deselect a result. Selected results are indicated by the yellow triangle to the left of the selected results as shown below. The selected results will then be used when the **[DELETE]**, **[ANALYZE]**, or **[PRINT]** soft keys are selected.
- **[DELETE]** – If no results are selected, then the result that is highlighted by the cursor is deleted. Otherwise, **[DELETE]** erases the selected results. Normally results are deleted to make data management easier. If Test Results need to be saved, they must be printed or stored in a computer file prior to deletion. On 21 CFR, Part 11 compliant instruments, the **[DELETE]** is not available.
- **[ANALYZE]** – Compute the mean, standard deviation, and relative standard deviation of the selected results. (The relative standard deviation is also known as the coefficient of variation or CV.) The analysis can be printed with **[PRINT]**.

TEST RESULTS				TEST RESULT ANALYSIS	
			6/15		
▶	1.	COMPOUND X	29-May-2012	12.809	
▶	2.	COMPOUND X	29-May-2012	12.814	SAMPLES: 5
▶	3.	COMPOUND X	29-May-2012	12.809	MEAN (AVERAGE): 12.8122
▶	4.	COMPOUND X	29-May-2012	12.818	SD: 0.0038
▶	5.	COMPOUND X	25-May-2012	12.811	RSD%(CV): 0.030 %
	6.	RAW MATERIAL 1	25-May-2012	13.055	
	7.	RAW MATERIAL 1	25-May-2012	13.055	
	8.	RAW MATERIAL 1	25-May-2012	13.055	
	9.	RAW MATERIAL 1	25-May-2012	13.054	
	10.	RAW MATERIAL 1	25-May-2012	13.056	
DELETE ANALYZE SEL ALL VIEW PRINT				PRINT	

The analysis is performed using the following formulas that are available on many hand calculators:

- o MEAN (average) = $\frac{\sum x}{n}$
- o SD (standard deviation) = $\sqrt{\frac{\sum(\bar{x} - x)^2}{n - 1}}$
- o RSD (relative standard deviation) expressed as percentage = $\frac{SD}{MEAN} \times 100\%$

- **[SEL ALL]** – Selects all of the Test Results stored in the instrument. The **[DELETE]**, **[ANALYZE]**, and **[PRINT]** soft keys can then be used to delete, perform statistical analysis on or print all of the Test Results.
- **[VIEW]** – View the test result that is highlighted by the cursor. There are 3 pages of data for each test result. If there is a graph available for this test, then the **[GRAPH]** soft key is displayed and can be used to view the graph.

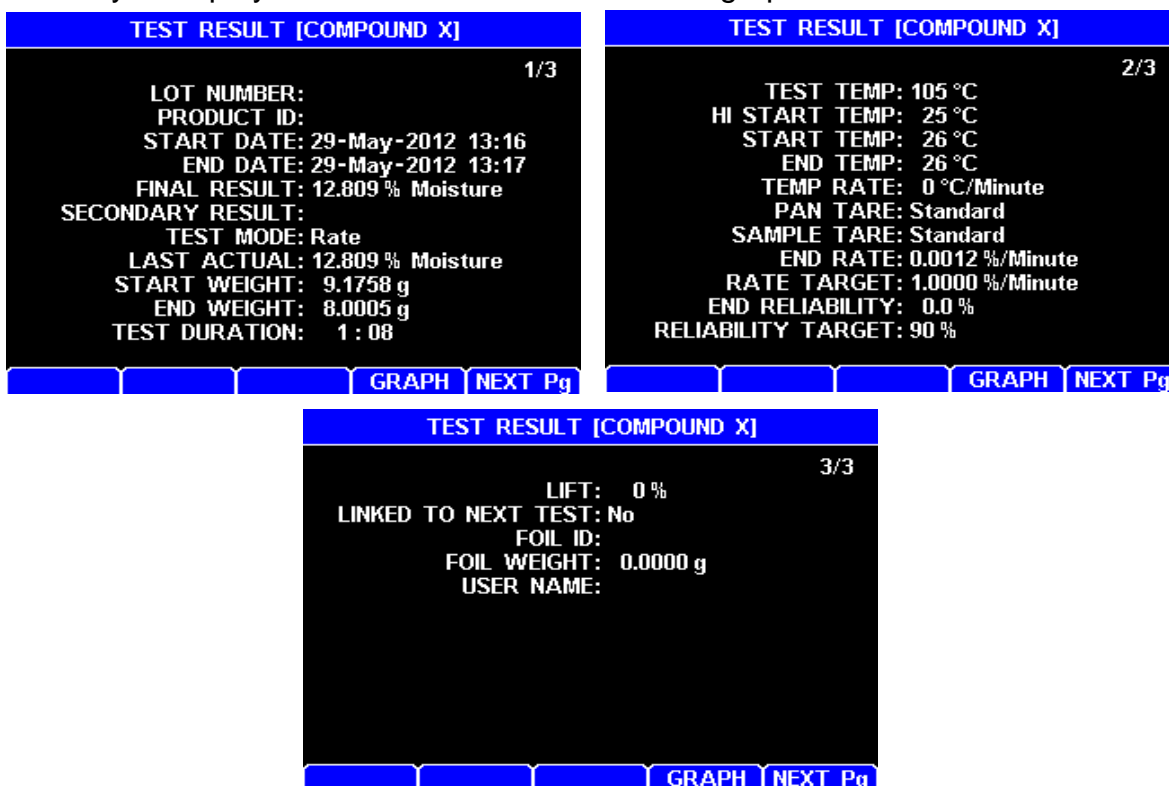

When viewing Test Results from linked tests, the middle soft key on the above screens will change to **[M-VIEW]**. Pressing **[M-VIEW]** will display the MULTIPLE TEST VIEW screen, which shows the final result of each of the linked tests on one screen. Press **[ESC]** to exit the MULTIPLE TEST VIEW screen.

- **[PRINT]** - If no results are selected, then the result that is highlighted by the cursor is printed. Otherwise, **[PRINT]** prints the selected results. Only report items that have been selected in the REPORT ITEMS TO PRINT menu will print (See section **8.4.2.B Report Items to Print** on page 71).

8.2.1 Graph

Available only on the MAX[®] 4000XL.

Pressing the **[GRAPH]** soft key from the Main Test screen or when viewing Test Results brings up the test graph. The **[RESULT]**, **[TEMP]**, **[PREDICT]**, and **[RATE]** soft keys allow their specific curves to be removed from or added to the graph. The color of the text in the soft key graph corresponds to the color of that specific graph: Blue for RESULT, Red for TEMP or PREDICT, and Orange for RATE.

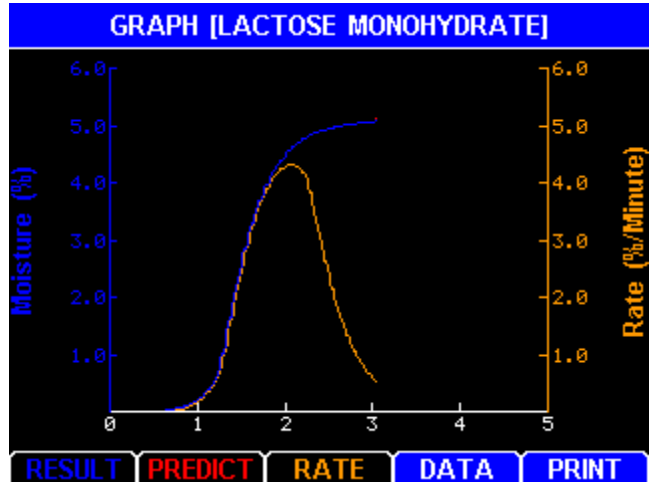

The specific curves that are available for viewing on the graph will vary depending on the ending criteria for the test being viewed. The **[PREDICT]** soft key is only shown on tests that use the Prediction ending criteria, while the **[TEMP]** soft key is only available on tests that do not use the Prediction ending criteria.

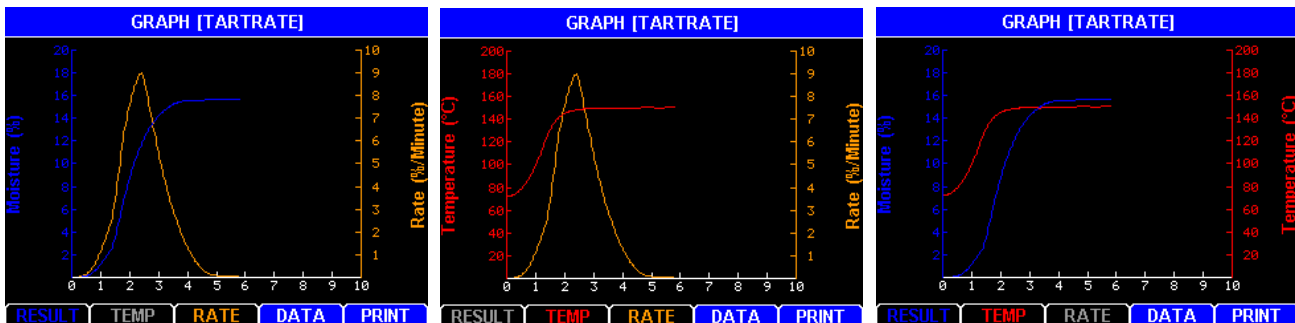

As shown in the three TARTRATE graphs above, the soft keys are used to toggle whether or not a particular curve is displayed:

- Press the corresponding soft key once to hide a particular curve from the graph.
- Press the soft key again to display the hidden curve.
- Press **[DATA]** to return the previous screen, either the Main Test screen or the Test Results display screen.

The graph can be printed by pressing **[PRINT]**.

8.3. Calibration Menu

To get here, navigate:
[MENU]→CALIBRATION MENU

The calibration menu provides access to the balance and heater calibration routines.

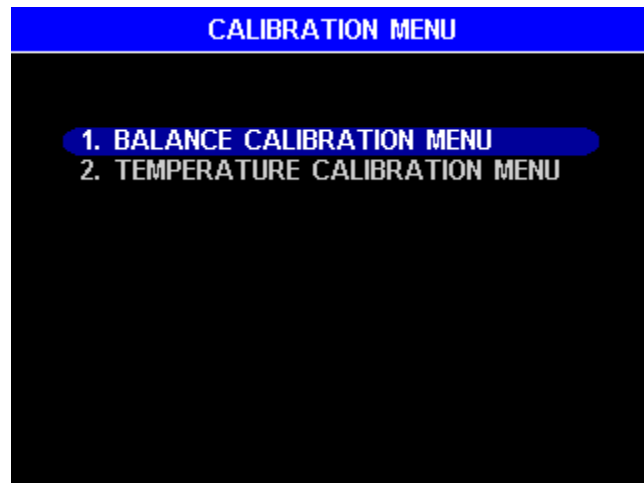

8.3.1 Balance Calibration Menu

To get here, navigate:
[MENU]→CALIBRATION MENU→BALANCE CALIBRATION MENU

Span calibration is used when setting up the instrument in a new location. The balance linearity should be stable throughout the balance's life. Linearity verification can be performed, if desired, but only on the MAX[®] 4000XL.



NOTE: From a cold start, allow the MAX[®] 4000 to warm up for 60 minutes prior to balance calibrations and verifications for optimum accuracy. The instrument should not be moved, jarred, or otherwise disturbed in any way during the calibration period. A vibration-free table will aid the calibration process. If vibration is excessive, the instrument will stop the calibration process and indicate the reason.

8.3.1.A View Calibration Report

To get here, navigate:

[MENU]→CALIBRATION MENU→BALANCE CALIBRATION MENU→
VIEW CALIBRATION REPORT

VIEW CALIBRATION REPORT displays the span calibration (and the optional linearity verification on the MAX[®] 4000XL). The report includes the information on both screens shown here and can be printed with the **[PRINT]** soft key on either screen.

To enable linearity verification reporting on the MAX[®] 4000XL, see section **8.3.1.C Linearity Verification Setup** on page 60. If linearity verification reporting has been enabled, the **[DETAIL]** button will be present, and pressing **[DETAIL]** will display the balance linearity verification results. Press **[SUMMARY]** to return to the balance calibration report.

BALANCE CALIBRATION REPORT			
SPAN CALIBRATION: 04-Oct-2007			
WEIGHT: 19.9999g Pass			
LINEARITY VERIFICATION: 13-Sep-2007			
DETAIL			PRINT
BALANCE LINEARITY VERIFICATION RESULTS			
TOTAL	MEASURED	WEIGHT	
10.0g	10.0000g	10.0000g	Pass
20.0g	20.0001g	10.0002g	Pass
30.0g	30.0002g	10.0001g	Pass
40.0g	39.9999g	9.9997g	Pass
	MEAN:	10.0000g	
SUMMARY			PRINT

8.3.1.B Perform Span Calibration

To get here, navigate:

[MENU]→CALIBRATION MENU→BALANCE CALIBRATION MENU→
PERFORM SPAN CALIBRATION

Span calibration should be done:

- Immediately after initial setup and 60-minute warm-up from cold start.
- Whenever the instrument is moved.
- Whenever a problem is suspected.
- As your quality policy dictates.

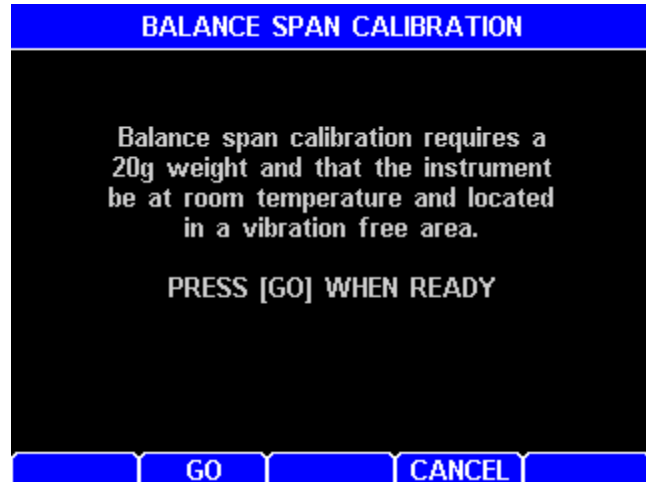

Performing the calibration:

- Select the PERFORM SPAN CALIBRATION menu item.
- The introduction screen is displayed; press [GO] to continue.
- The heat chamber must be less than 50 °C; otherwise, the instrument delays the calibration until the chamber cools adequately. If this occurs, the lid can be opened to speed up the cooldown.
- Follow the instructions. A 20g weight is used to calibrate the balance. The weight is loaded twice during the span calibration: one time for calibration and a second time for verification. **During the weight loading and removal, avoid excess pressure on the balance. Use the tweezers included with the MAX[®] 4000 to gently place the weight on the pan.**
- After successful calibration, the calibration report is displayed.
- If the calibration routine failed or the verification weight value fails, rerun the calibration. If the calibration fails again, contact Customer Service.

8.3.1.C Linearity Verification Setup

To get here, navigate:

[MENU]→CALIBRATION MENU→BALANCE CALIBRATION MENU→
LINEARITY VERIFICATION SETUP

If you are using a MAX[®] 4000XL, linearity verification can be performed if desired. With a few exceptions for certain industries, this feature is not generally used. This screen allows recording of the weight kit information for the weight kit that will be used for the linearity verification.

The following options are available:



- ENABLE REPORTING – When enabled, the linearity verification results are added to the BALANCE CALIBRATION REPORT.
- SN – Serial Number for the weight kit.
- CERT DATE – Certification date of the weight kit.
- SIZE – Individual size of the weights in the kit. All weights must be the same size if NIST Class F or ASTM Class 5 weights are used. If ASTM Class 1 or 2 weights are used, then a combination of different sized weights can be used to create equal weight increments. See the examples below for clarification.
- COUNT – The number of weight increments.

Depending on your specific needs, the linearity of the balance can be verified across the full range of the balance to 40 grams or across any smaller range, such as from 0 to 2 grams or 0 to 10 grams. The range to be verified and the weights to be used will determine the SIZE and COUNT values to be input.

For example,

- To verify the linearity across the range 0 to 10 grams, using 5 2g weights, SIZE would be 2g and COUNT would be 5.
- ASTM Class 2 weights of 5g, 10g, and 20g can be used to create equal weight increments of 5g from 0g to 35g, allowing linearity verification of the range from 0 to 35 grams. In this case, SIZE is 5g and COUNT is 7 since $5g \times 7 = 35g$. During the verification, the MAX[®] 4000XL will prompt for:
 - 1 x 5g – use the 5g weight,
 - 2 x 5g – use the 10g weight,
 - 3 x 5g – use the 5g and the 10g weight
 - 4 x 5g – use the 20g weight.

Continue in this manner until all three weights are used for 7 x 5g at 35 grams.

8.3.1.D Perform Linearity Verification

Available only on the MAX[®] 4000XL.

Linearity verification should be done as dictated by your quality policy.

Performing the verification:

- Press the **[PROGRAM]** soft key, highlight the (Factory) IDLE Test Program, press **[ENT]**, then press **[ESC]**. (This sets the instrument idle temperature to 25 °C).
- From a cold start, allow the instrument to warm up for 60 minutes before proceeding.
- Navigate **[MENU]**→CALIBRATION MENU→BALANCE CALIBRATION MENU→PERFORM LINEARITY VERIFICATION
- Select the PERFORM LINEARITY VERIFICATION menu item.
- The introduction screen is displayed; press **[GO]** to continue.
- The heat chamber must be less than 30 °C and the cool down fan must be off; otherwise, the verification aborts with a “Too hot” message and must be restarted.
- Follow the instructions. (Two examples are shown on the previous page). **During the weight loading and removal, avoid excess pressure on the balance. Use the tweezers included with the MAX[®] 4000 to gently place the weights on the pan.**
- After successful verification, the calibration report is displayed.
- If the verification routine failed or the verification weight value fails, rerun the verification. If the verification fails again, contact Customer Service.

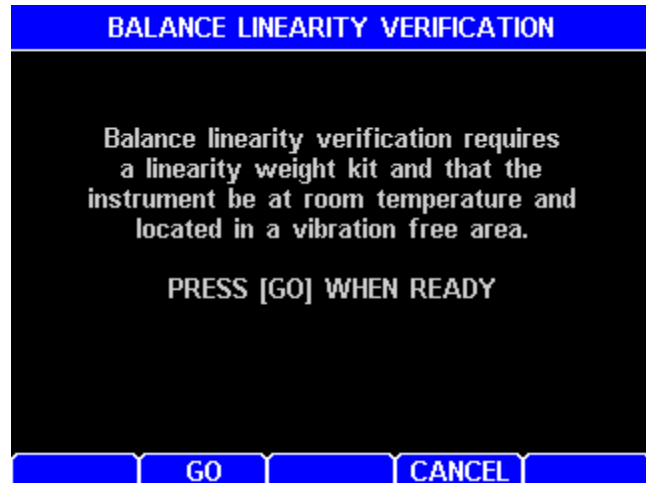

8.3.1.E Span Calibration Reminder Setup

To get here, navigate:

[MENU]→CALIBRATION MENU→BALANCE CALIBRATION MENU→SPAN CAL REMINDER SETUP

A span calibration reminder prompt is available to automatically remind you to run the balance span calibration at the interval dictated by your policies or procedures.

The following options are available:

- ENABLE turns on/off the reminder. The factory default setting is **No** (off).
- TIME specifies the time that the prompt appears using a 24-hour format. This is usually set to the start of the shift.
- INTERVAL - The interval between calibrations in weeks. If the interval is set to “0”, the reminder will occur daily.



8.3.2 Temperature Calibration

To get here, navigate:

[MENU]→CALIBRATION MENU→TEMPERATURE CALIBRATION MENU

All six menu options shown are available on the MAX[®] 4000XL, but on the MAX[®] 4000, only the first option VIEW CALIBRATION REPORT is available, since Temperature Calibration and Verification functionality is only available on the MAX[®] 4000XL.

The MAX[®] 4000XL temperature calibration routines calibrate and verify the accuracy of the oven temperature throughout the usable range. The oven is calibrated at 10 preset increments and verified at user selectable temperatures.

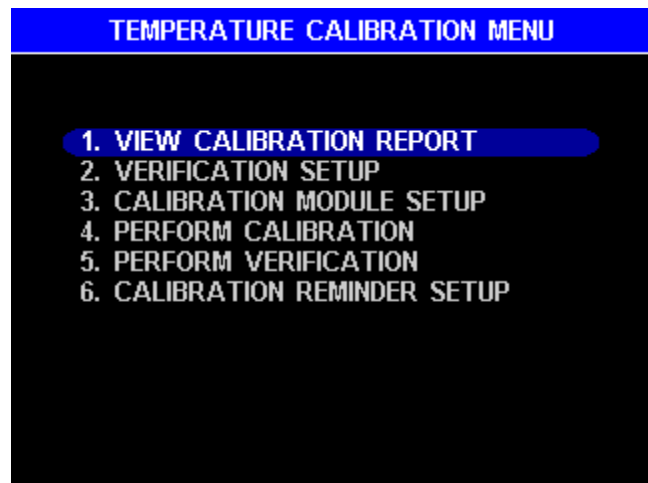

The Temperature Calibration Kit is required (See section **5.4 Inventory & Accessories** on page **14**). This kit contains an NIST traceable device that measures the temperature at the sample position.

Note: For optimum performance, perform the calibration in an environment that is free from air currents and general activity (evenings or smaller staffed shifts are best).

Before performing Temperature Calibration:

- Navigate **[MENU]**→**SETUP MENU**→**PRINTER SETUP**.
- Verify that **OUTPUT TO COMPUTER** is set to **No**. Change it to **No** if necessary.
- Press **[ESC]** until back at the Main Menu.

Since the TCI port can also be used to output data to a computer, in order to ensure communication between the instrument and the TCI, data output through this port must be turned off during temperature calibration. If you typically output data from the instrument to a PC, be sure to re-enable this function when temperature calibration is complete. See **8.4.1 Printer Setup** on page **69** for additional details.

Connecting the Temperature Calibration Kit:

- Open the lid.
- Use the supplied tweezers to remove the pan support; place the tweezers' tips under the pan support and pry the pan support straight up and out of the balance stem. **Be careful; excess force on the balance can result in costly repairs.**
- Set the pan support aside during the calibration.

- Place the RTD calibration disk onto the top of the balance cover so that the disk support sinks into the center hole of the balance cover.
- Turn the RTD calibration disk so that the wires are positioned at the 4:30 clock position, when facing the instrument from the front, as shown.
- Plug the RTD calibration disk cable into the matching connector on the Temperature Calibration Interface (TCI) Module, as shown.



- Connect the RS-232 serial cable to the matching connector on the TCI module and to the "TCI" port on the back of the instrument, as shown.

- Connect the 9VDC adapter to the TCI Module and to an appropriate AC outlet, as shown.

- After calibration, be sure to disconnect the TCI from the TCI port on the instrument prior to printing any reports.

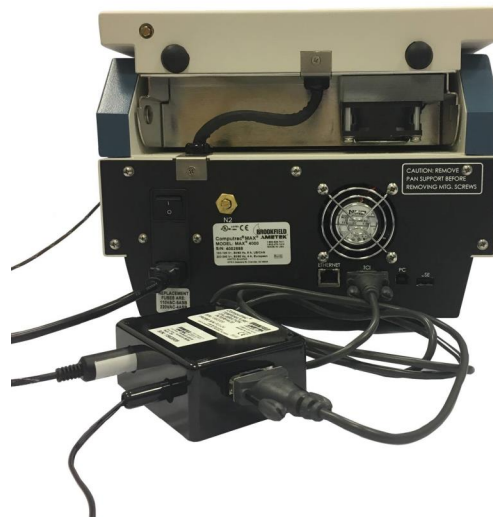

To AC
Power
Adapter

8.3.2.A View Calibration Report

To get here, navigate:

[MENU]→CALIBRATION MENU→TEMPERATURE CALIBRATION MENU→
VIEW CALIBRATION REPORT

View Calibration Report shows the last calibration, last verification, and the Temperature Calibration Kit information. The report can be printed with **[PRINT]**, but be sure to disconnect the TCI from the instrument's TCI port prior to printing any reports.

TEMPERATURE CALIBRATION REPORT			
LAST CALIBRATION: 25-Apr-2008			
LAST VERIFICATION: 25-Apr-2008			
MODULE #: 1560074			
PROBE #: 2046			
MODULE CERT DATE: 01 - Aug - 2007			
MAX VERIFY ERROR: 0.3 °C AT 49.9 °C			
DETAIL			PRINT

[DETAIL] gives a listing of the temperature verification results

TEMPERATURE VERIFICATION RESULTS			
INSTRUMENT	TCI	DIFFERENCE	
49.9	49.6	0.3	Pass
74.8	74.7	0.1	Pass
100.0	100.0	0.0	Pass
125.0	125.0	0.0	Pass
149.9	150.1	0.2	Pass
175.0	175.1	0.1	Pass
200.0	200.1	0.1	Pass
225.1	224.9	0.2	Pass
250.1	250.1	0.0	Pass
275.1	275.0	0.1	Pass
SUMMARY			PRINT

8.3.2.B Verification Setup

Available on the MAX® 4000XL only

To get here, navigate:

[MENU]→CALIBRATION MENU→TEMPERATURE CALIBRATION MENU→
VERIFICATION SETUP

Verification Setup allows customization of the temperature verification step that is performed after the temperature calibration.

The following options are available:

- AUTO VERIFY AFTER CAL enables the auto verification following a calibration. If time is critical and only calibration is desired, then disable auto verification.
- ADDITIONAL VERIFY TOL – The pass/fail tolerance criteria for the verification can be increased from the factory calibration standard of ± 1.5 °C to match your quality standards or standard operating procedures (SOP's).
- POINTS TO VERIFY options are:
 - All Cal Points – All 10 standard calibration points are verified.
 - 1/2/3/4 Custom Pt(s) – Up to 4 custom calibration points can be verified instead of the 10 standard calibration points.
- CUSTOM TEMP VERIFICATION POINTS – If custom calibration points are going to be used, those temperatures are specified here. Up to 4 custom calibration points can be verified instead of the 10 standard points, if POINTS TO VERIFY is set accordingly.

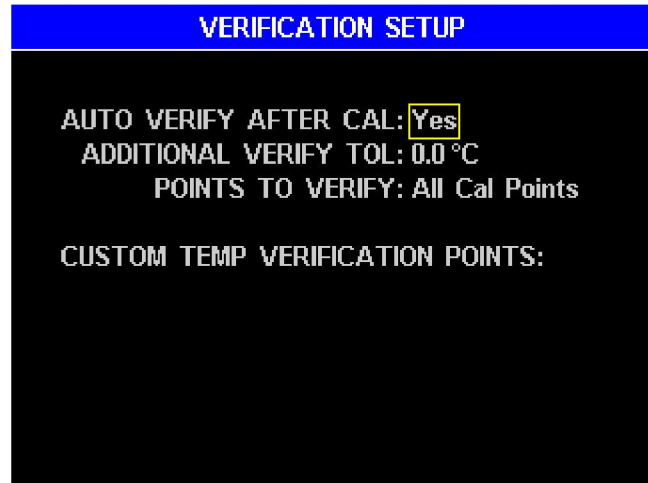

8.3.2.C Calibration Module Setup

Available on the MAX® 4000XL only

To get here, navigate:

[MENU]→CALIBRATION
MENU→TEMPERATURE CALIBRATION
MENU→
CALIBRATION MODULE SETUP

This menu item allows entry of the Temperature Calibration Kit's module number, probe number, and certification date. This information is located on the Temperature Calibration Interface (TCI) Module.

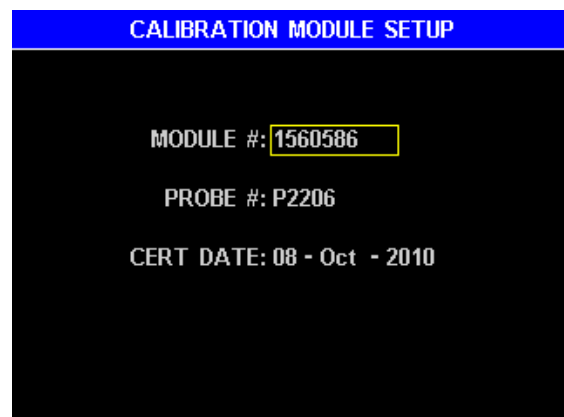

8.3.2.D Perform Calibration

Available on the MAX[®] 4000XL only

To get here, navigate:

[MENU]→CALIBRATION MENU→TEMPERATURE CALIBRATION MENU→
PERFORM CALIBRATION

This selection performs the temperature calibration (and auto verification if enabled) of the MAX[®] 4000XL when the Temperature Calibration Kit is connected.

Performing the calibration:

- Connect the Temperature Calibration Kit as described in section **8.3.2 Temperature Calibration** on page **62**.
- Select the PERFORM CALIBRATION menu item.
- The introduction screen is displayed; Follow the instructions.
 - **ATTEMPTS: 3** is the default total number of calibration attempts. If the calibration fails, it will repeat two additional times (by default) or up to the number of **ATTEMPTS:** entered if the value is changed from the default.
- Then press **[GO]** to continue.
- Wait for the calibration to finish.
- Open the lid and wait for the MAX[®] 4000 to cool.
- Disconnect the TCI and remove the temperature calibration disk.
- Gently but firmly install the pan support into the balance stem.

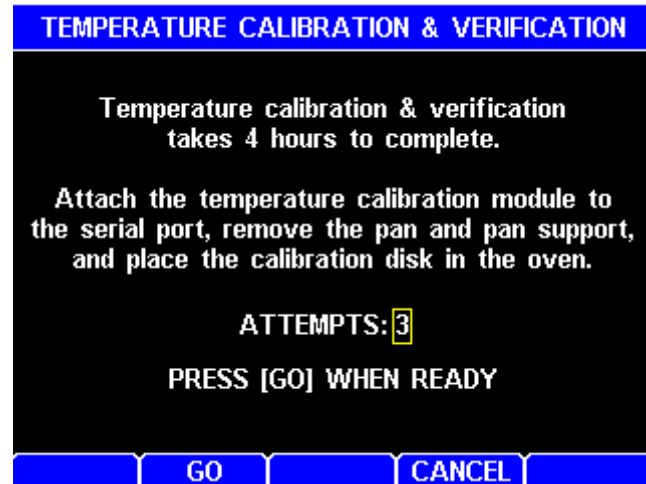

During the calibration, the Temperature Calibration Interface (TCI) Module reports its temperature reading to the MAX[®] 4000XL. The calibration process monitors the MAX[®] 4000XL's temperature (in the heat chamber) and the TCI's temperature. Any difference between the two readings is used by the MAX[®] 4000XL to correct its temperature reading. The verification process monitors the MAX[®] 4000XL's corrected temperature (in the heat chamber) and the TCI's temperature and reports the difference between the two.

8.3.2.E Perform Verification

Available on the MAX[®] 4000XL only

To get here, navigate:

[MENU]→CALIBRATION MENU→TEMPERATURE CALIBRATION MENU→
PERFORM VERIFICATION

This selection performs the temperature verification of the MAX[®] 4000 when the Temperature Calibration Kit is connected.

Performing the verification:

- Connect the Temperature Calibration Kit as described in section **8.3.2 Temperature Calibration** on page **62**.
- Select the PERFORM VERIFICATION menu item.
- The introduction screen is displayed; Follow the instructions.
- Then press **[GO]** to continue.

- During the verification, press **[DETAIL]** to view real-time results at each verification point, if desired.
- Wait for the verification to finish.
- Open the lid and wait for the MAX[®] 4000XL to cool.
- Disconnect the TCI and remove the temperature calibration disk.
- Gently but firmly install the pan support into the balance stem.



TEMPERATURE VERIFICATION RESULTS

INSTRUMENT	TCI	DIFFERENCE
49.9	49.6	0.3 Pass
74.8	74.7	0.1 Pass
100.0	100.0	0.0 Pass
125.0	125.0	0.0 Pass

STATUS ABORT

During the verification, the Temperature Calibration Interface (TCI) Module reports its temperature to the MAX[®] 4000XL. The verification process monitors the MAX[®] 4000XL's temperature (in the heat chamber) and the TCI's temperature, and reports the difference between the two.

The verification can be run at any time, and can also be set to run automatically after a temperature calibration, as set in section **8.3.2.B Verification Setup** on page **65**.

8.3.2.F Calibration Reminder Setup

Available on the MAX[®] 4000XL only

To get here, navigate:

[MENU]→CALIBRATION MENU→TEMPERATURE CALIBRATION MENU→
CALIBRATION REMINDER SETUP

A temperature calibration reminder prompt is available.

The following options are available:

- ENABLE turns on/off the reminder. The factory default setting is **No** (off).
- TIME specifies the time that the prompt appears using a 24-hour format. This is usually the start of a shift.
- INTERVAL - The interval between calibrations in weeks. If the interval is set to "0", the reminder will occur daily.

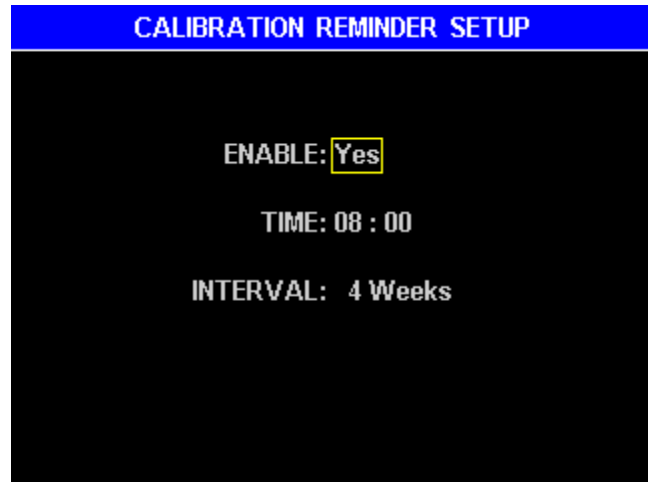

8.4. Setup Menu

To get here, navigate:

[MENU]→SETUP MENU

The SETUP MENU is used to program the MAX[®] 4000 with information relevant to all operations and tests. As explained in the following sections, from the SETUP MENU, it is possible to set up or modify all instrument configuration options, including setting up a printer, specifying report options, setting the date and time, configuring Ethernet options, and administering user logins.

After making changes in the SETUP MENU, press **[ESC]** until back at the Main Menu to save the changes.



8.4.1 Printer Setup

To get here, navigate:
[MENU]→SETUP MENU→PRINTER
SETUP

PRINTER SETUP allows the configuration of data output to a computer, printer or USB drive. Graphics are not sent to the computer or USB drive, only to the printer.

The following options are available:



- OUTPUT TO COMPUTER enables reporting to both the RS232 and the USB computer ports. Reports sent to a PC include a footer with the date and time.
NOTE: This must be set to **No** prior to Temperature Calibration.
- OUTPUT TO USB DRIVE enables reporting to a USB drive. Make sure to insert the drive in the USB Type A / Host port (marked **USB**) before printing the report. When the desired report is printed, a file name is constructed from the instrument's serial number with a ".TXT" extension (for example "4000005.TXT") and saved to the drive. As reports are printed, they are appended to this file along with a footer listing the date and time. Always wait 5 seconds after a report finishes prior to removing the drive to allow the instrument to close the file. Otherwise, drive corruption can occur.
- OUTPUT TO PRINTER enables reporting to the printer.
- If using the standard printer (Y990-0212), the [TEST] soft key can be used to send a test pattern to the printer. If the test pattern prints, then the printer and the MAX[®] 4000 are communicating properly. The [TEST] soft key does not send the test pattern to a connected computer, USB drive or a mini-printer.

See section **6.7 Connecting a USB Printer** on page **21** and section **6.9 Connecting a Computer** on page **22** to connect the MAX[®] 4000 to a printer and/or a computer.

8.4.2 Report Setup

To get here, navigate:
[MENU]→SETUP MENU→REPORT
SETUP

This menu allows the reports to be enabled and customized to your needs.

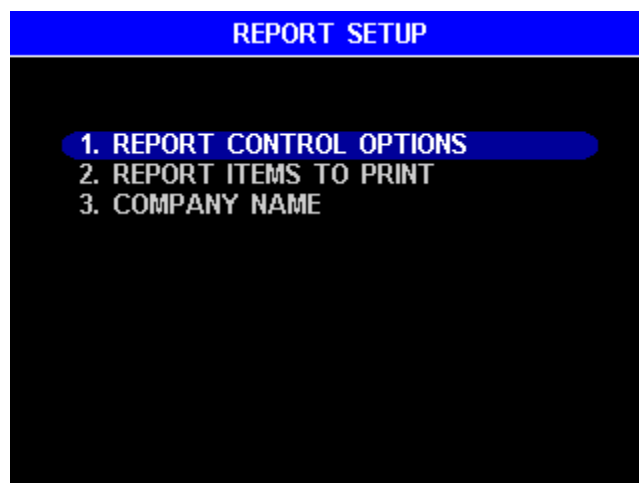

8.4.2.A Report Control Options

To get here, navigate:

[MENU]→SETUP MENU→REPORT SETUP→REPORT CONTROL OPTIONS

Report control options determine how often during a test a report is generated and sent to the printer, computer or drive.

The following options are available:

- REPORT ENABLED enables a final report after a test and an optional progress report during a test, as explained in REPORT START below.
- REPORT START:
 - Test Start prints a progress report beginning at the start of a test along with the final results. This is useful while developing a test program.
 - First Prediction prints a progress report beginning at the start of the first prediction along with the final results.
 - Test End only prints the final results after a test.
- REPORT INTERVAL determines how often the progress report data is printed. Times of 1, 5, 10, 15, and 30 seconds or 1 minute are available. The short durations are good for test program development and the long intervals are good for normal use.
- INCLUDE GRAPH prints a moisture graph after the final results. Graphic data is not sent to the computer or USB drive, however, only to the printer. Only the MAX[®] 4000XL has Test Graphs.

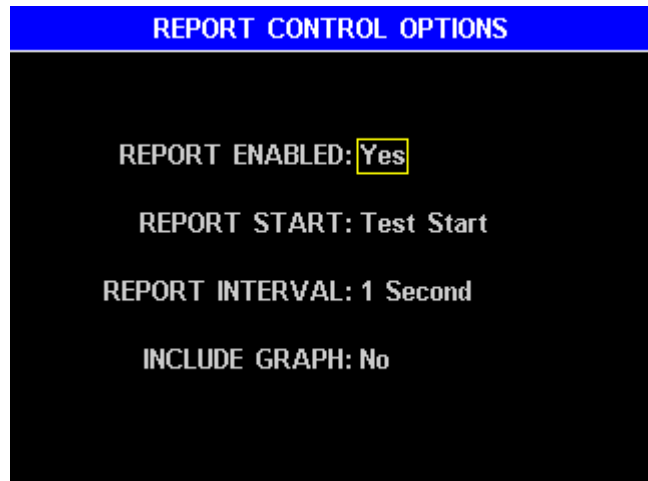

8.4.2.B Report Items to Print

To get here, navigate:

[MENU]→SETUP MENU→REPORT SETUP→REPORT ITEMS TO PRINT

Test Results consist of many pieces of information that may or may not be useful in your application. To avoid producing a report with more data than is required, you can choose which items are printed on the report. Select or deselect the items that you want printed from the Test Results, using [ENT] to toggle the check marks. There are two pages of options; use [NEXT Pg] to switch between pages. When the options are configured as desired, press [ESC] until back at the Main Menu to save the changes.

REPORT ITEMS TO PRINT		REPORT ITEMS TO PRINT	
<input checked="" type="checkbox"/> Sample Name	<input checked="" type="checkbox"/> Test Duration	<input checked="" type="checkbox"/> End Reliability	
<input checked="" type="checkbox"/> Lot Number	<input checked="" type="checkbox"/> Test Temp	<input checked="" type="checkbox"/> Reliability Target	
<input checked="" type="checkbox"/> Product ID	<input checked="" type="checkbox"/> Hi Start Temp	<input checked="" type="checkbox"/> Lift %	
<input checked="" type="checkbox"/> Start Date/Time	<input checked="" type="checkbox"/> Start Temp	<input checked="" type="checkbox"/> Link Options	
<input checked="" type="checkbox"/> End Date/Time	<input checked="" type="checkbox"/> End Temp	<input checked="" type="checkbox"/> Foil ID	
<input checked="" type="checkbox"/> Pass/Fail	<input checked="" type="checkbox"/> Temp Rate	<input checked="" type="checkbox"/> Foil Weight	
<input checked="" type="checkbox"/> Test Mode	<input checked="" type="checkbox"/> Pan Tare	<input checked="" type="checkbox"/> User Name	
<input checked="" type="checkbox"/> Last Actual	<input checked="" type="checkbox"/> Sample Tare		
<input checked="" type="checkbox"/> Start Weight	<input checked="" type="checkbox"/> End Rate		
<input checked="" type="checkbox"/> Start Wt Target	<input checked="" type="checkbox"/> Rate Target		
<input checked="" type="checkbox"/> End Weight			
	NEXT Pg		NEXT Pg

8.4.2.C Company Name

To get here, navigate:

[MENU]→SETUP MENU→REPORT SETUP→COMPANY NAME

The COMPANY NAME prints at the top of reports and may be used to show the company name, test location, or other alphanumeric identifier.

COMPANY NAME
NAME: <input type="text" value="PREFERRED CUSTOMER"/>

8.4.3 Date/Time Setup

To get here, navigate:

[MENU]→SETUP MENU→DATE/TIME
SETUP

Use this function to change the time at initial setup or when changing for daylight savings time. Time is in a 24-hour format.



An internal battery maintains the correct time and date when the power is off. If an “RTC Battery Failure” occurs and/or the clock resets when the power is turned off and on, the internal backup battery may need to be replaced. If this happens, call Customer Service.

A battery failure does not affect the instrument’s Test Programs, Test Results or configuration options stored in memory because this information is stored in non-volatile memory and is not dependent on the battery.

8.4.4 Ethernet Setup

To get here, navigate:

[MENU]→SETUP MENU→ETHERNET SETUP

An optional Web Server can be purchased for the MAX[®] 4000XL, and then the instrument can be accessed from your local area network (LAN) or intranet by a Windows[®] PC with Internet Explorer[®] version 6 or higher. The Ethernet Setup menu provides the necessary options to configure this connection. Generally, the MAX[®] 4000XL cannot be viewed on the Internet because of company firewalls, but it is possible and requires a registered IP address.

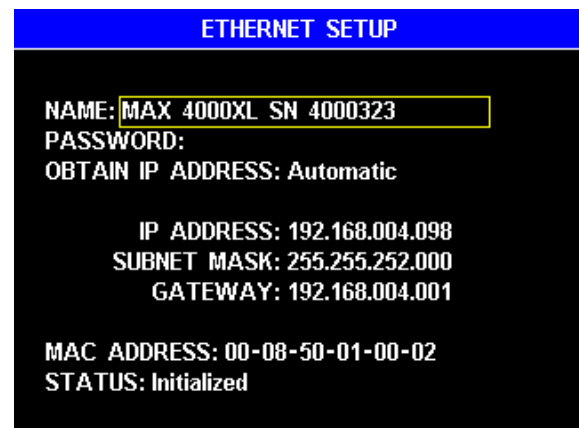

After making changes in the Ethernet Setup menu, press **[ESC]** until back at the Main Menu, and then cycle the instrument power off and on to save the changes.

If the web server option is not purchased, the MAX[®] 4000XL can still be accessed over the intranet to test the LAN connection, but reports, data, and other functionality will not be available.

The following options are available:

- **NAME & PASSWORD** are used to restrict access to the instrument over the intranet. When using IE enter **NAME** for the Username and enter **PASSWORD** for the Password to gain access to the instrument.



- **OBTAIN IP ADDRESS** options are:
 - **Ethernet Off** disables the Ethernet port.
 - **Manual** requires the manual entry of IP Address, Subnet Mask, and Gateway. Consult with your Information Services (IS) department for the correct settings.
 - **Automatic** sets everything automatically (factory default). A DHCP server on the network is required in order to use automatic mode. This mode is useful to check the operation of the MAX[®] 4000XL Web Server, but because the DHCP server may assign a new IP address each time the MAX[®] 4000XL is powered on, the end user would need to check the MAX[®] 4000XL Ethernet Setup screen to verify that the correct instrument IP address is used by Internet Explorer[®] to access the MAX[®] 4000XL. Therefore, the Manual mode is generally preferred.
- **MAC ADDRESS** is factory set and is unique to every Internet device. It may be helpful to your IS department.
- **STATUS** displays the Ethernet status. If everything is setup and connected correctly, then STATUS displays “Initialized” shortly after power up.

If **OBTAIN IP ADDRESS** is set to Manual, do not use an IP address for the MAX[®] 4000XL that conflicts with another IP address on your network. Conflicting IP addresses may cause network crashes or instability. As an additional safeguard against conflicts, the MAX[®] 4000XL will not accept IP addresses that end in .255 or .1.

See section **9 WEB SERVER** on page **86** for details on the Web Server. Call Customer Service for more information and purchasing questions.

8.4.5 Misc Options

To get here, navigate:

[MENU]→SETUP MENU→MISC OPTIONS

The following options are available:

- LOT NUMBER - If enabled, starting a test brings up the ENTER LOT NUMBER AND PRODUCT ID screen, shown below. These alphanumeric entries may be used to insert the lot designation and unique product identification into reports. Not all industries or processes use this feature, so it is turned Off by default. Set LOT NUMBER to On to enable this feature.
- FAN COOL DOWN enables the lid fan to cool down the instrument after a test. This is normally used to speed throughput. To utilize this capability, leave the lid open after testing and close the lid when the fan turns off. The lid may be closed prior to the fan turning off, but the instrument will take longer to reach a stable idle temperature.
- DISPLAY LOW SAMPLE LOAD allows the user to see the sample weight continuously while loading sample and reduces the chance of overshooting the intended sample size, as explained on the next page.



If LOT NUMBER is enabled, then the following screen options are available when starting a test:

- LOT NUMBER – Alphanumeric code to identify the product lot number.
- PRODUCT ID - Alphanumeric code used by some companies to identify specific products.

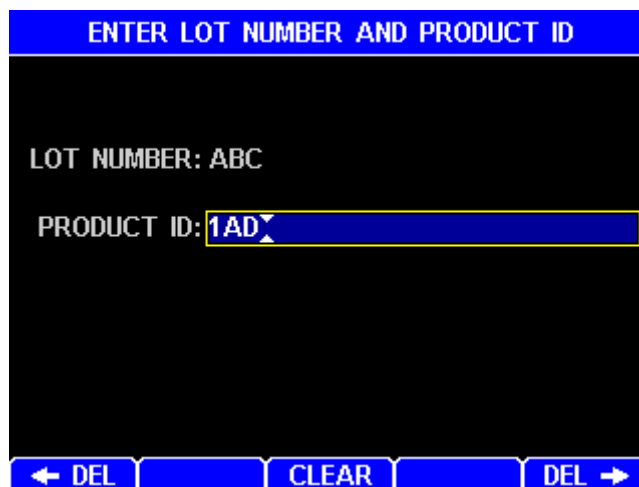

If the LOT NUMBER and PRODUCT ID for the samples to be tested are identified by bar coding, the LOT NUMBER and PRODUCT ID values can be scanned into the MAX[®] 4000 using the Bar Code Reader (P/N: GV-1412). Highlight the desired item, then scan the corresponding bar code for the sample and the values will automatically be entered.

If DISPLAY LOW SAMPLE LOAD is enabled, screens similar to the one below will be displayed during sample loading. In this example, the target sample size is 5g and the sample window is 0.3g. The initial LOAD SAMPLE screen (below left) shows a value of 4.4g, which is (Sample Size – 2 x Sample Window). When the loaded weight reaches 4.4g, the display switches to the normal LOAD SAMPLE window (below right). This feature reduces the chance of overshooting the intended sample size when loading the pan, as the sample weight is continuously visible.



8.4.6 Nitrogen Control Module

To get here, navigate:

[MENU]→SETUP MENU→NITROGEN CONTROL MODULE

This menu enables the Nitrogen Control module (See section **6.12 Nitrogen Control Module** on page 29).

The following options are available:

- **ENABLE N2 DURING TESTS** enables the module and requires that it be connected with good pressure. When appropriate, error messages are displayed during a test and when returning to the main screen at the end of a test.
- **NITROGEN VALVE** manually controls the operation of the valve if **ENABLE N2 DURING TESTS** is set to “Yes” and may be used for diagnostic purposes. Starting the next test will reset the valve to its proper state.
- **NITROGEN PRESSURE** displays the status of the nitrogen pressure from the regulator.
- **FIRMWARE VERSION** displays the firmware version of the module.

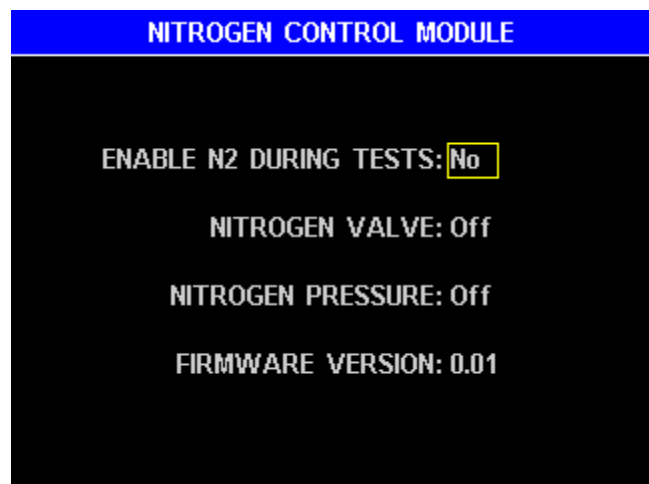

These options are not applicable if nitrogen purge is being used without the Nitrogen Control module.

8.4.7 Login Setup

To get here, navigate:

[MENU]→**SETUP MENU**→**LOGIN SETUP**

This menu allows the setup of user logins. If User Login is active, access to calibration and configuration options can be restricted to authorized users. When active on the MAX[®] 4000XL, users are required to login prior to testing and the username is recorded with each test result. Up to 20 users can be configured. A logged in user is automatically logged out if the instrument power is interrupted.



The following options are available from the LOGIN SETUP screen:

- **ACTIVATE LOGIN:** If set to Yes, users are required to login prior to testing.
- **ADMIN KEY** is the key required to access the LOGIN SETUP menu.
- **USERS** soft key – Access the USER EDIT screen to perform edits to the user list.

USER EDIT screen keypad functions are:

- **[ENT]:** Edit the user record.
- **[CUT]:** Copy the current user into temporary memory and delete it from the list. The user can be optionally inserted at another location.
- **[ADD]:** Add a new user to the list.
- **[INSERT ↑]** or **[INSERT ↓]:** Insert the user that is in temporary memory into the list either above or below the current user. The following users are moved down.

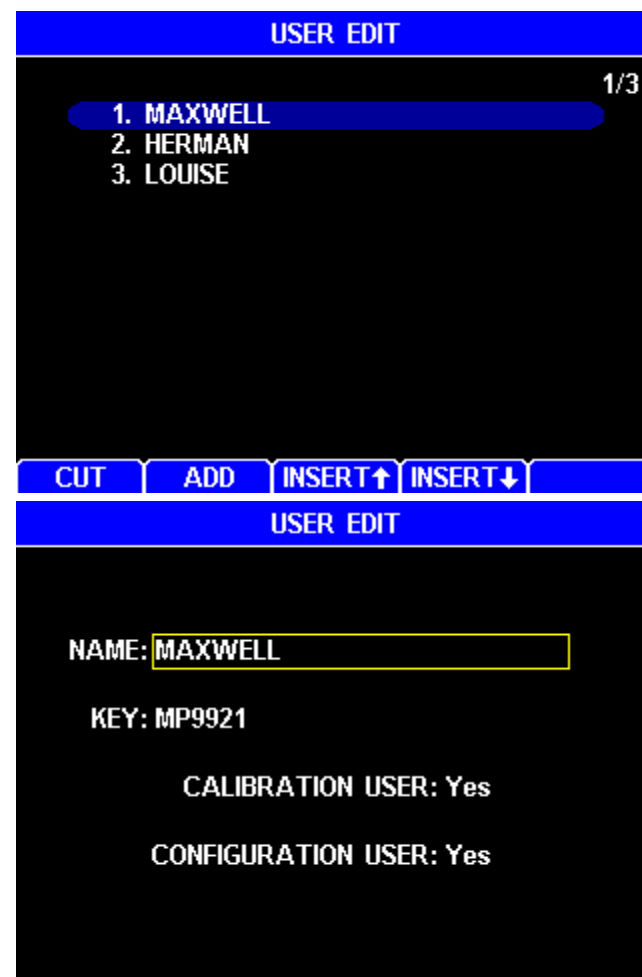

When editing a user record, the following options are available:

- **NAME:** Set to the desired username
- **KEY:** Set to the desired Access key for this user.
- **CALIBRATION USER:** Use **[ENT]** to toggle Yes or No. Refer to the next page for an explanation.
- **CONFIGURATION USER:** Use **[ENT]** to toggle Yes or No. Refer to the next page for an explanation.
- When done editing, press **[ESC]** to save and return to the list of users.

- A standard user that is not a Calibration User or Configuration User has the ability to perform tests and view data and reports but is not able to modify any settings or parameters, perform any calibrations or delete any test results.
- In addition to the standard user permissions, a Configuration User also has the ability to change instrument setup selections, add, delete or change test programs, and delete data (except on 21CFR compliant units).
- In addition to the standard user permissions, a Calibration User also has the ability to perform balance and temperature calibrations.

If User Login is activated, the fifth soft key on the Main Test Screen will change to LOGIN or LOGOUT as shown below, depending on whether a user is currently logged in. When User Login is activated on the MAX[®] 4000XL, a test cannot be performed unless a user is logged in.

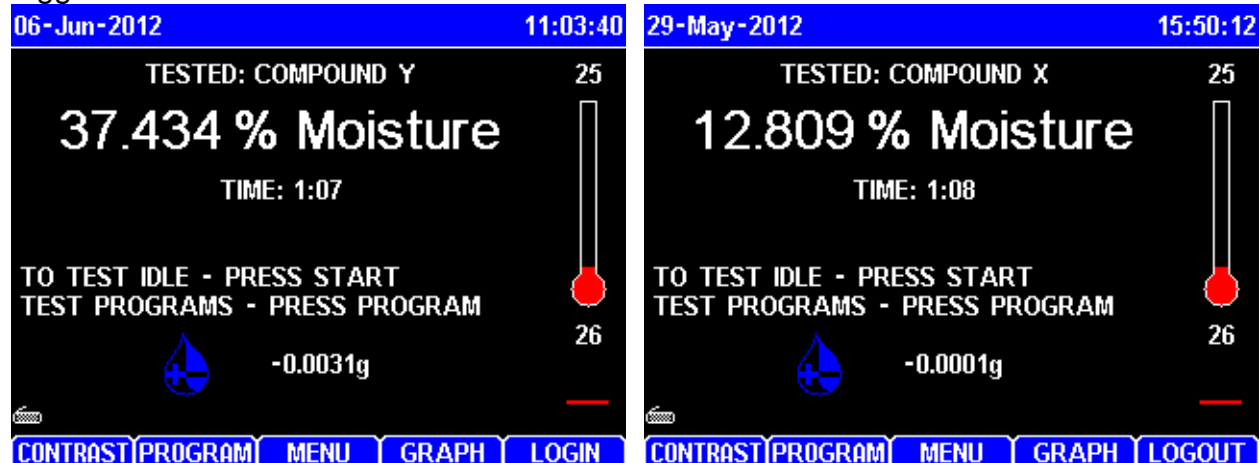

Pressing LOGIN will display the USER LOGIN screen. Highlight the desired user and press [ENT] to access the USER KEY ENTRY screen for that user or press [ESC] to return to the Main Test Screen without logging in.



On the USER KEY ENTRY screen, enter the user's access key and press [ENT]. If the correct key is entered, the selected user will be logged in, the instrument will return to the Main Test Screen, and the fifth soft key will now say LOGOUT. If User Login is enabled but the Access Key is left blank for a given user, then the User Key is not required, and the USER KEY ENTRY screen is not displayed for that user.

To change users, press LOGOUT, then press LOGIN and select the desired user.

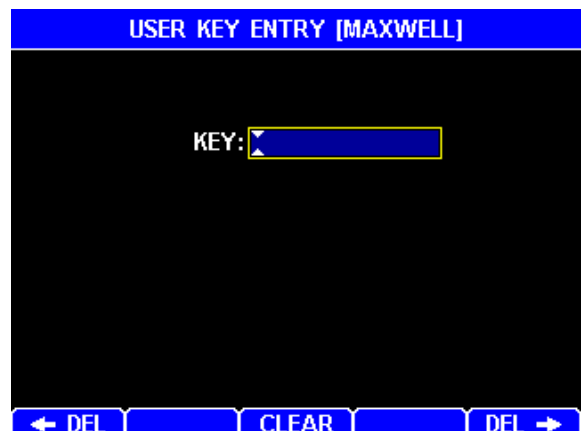

8.4.8 Special Features

To get here, navigate:

[MENU]→SETUP MENU→SPECIAL FEATURES

This menu is used to enable optional features for the instrument, such as the Web Server, and also shows what features are active. If you purchase one of these features, you will be given an access code to enable or disable the feature. Entering the code toggles the feature on or off.



This menu also indicates whether your instrument is a MAX[®] 4000 or MAX[®] 4000XL and whether 21 CFR, Part 11 compliance has been enabled, preventing the deletion of Test Results or Audit Log Events.

For more information regarding the special features available on your instrument, please call your technical salesperson or Customer Service.

8.5. Balance Mode

To get here, navigate:

[MENU]→BALANCE MODE

BALANCE MODE allows the use of the MAX[®] 4000 as a high precision balance when not analyzing samples. The balance has a 40g maximum load. **To prevent damage, do not overload the balance.**



After placing a clean sample pan on the pan support, use [START] to tare the balance. Wait approximately five seconds for the readings to stabilize, then proceed using normal balance protocol to weigh the desired sample or items. The lid may be closed to minimize variations in the reading due to air currents.

8.6. Parameter Expert

Available on the MAX[®] 4000XL only

To get here, navigate:

[MENU]→PARAMETER EXPERT MENU

The Parameter Expert (PE) assists a user through the development of a Test Program.



8.6.1 Develop New Test Program

To get here, navigate:

[MENU]→PARAMETER EXPERT MENU→
DEVELOP NEW TEST PROGRAM

For new Test Programs, the Parameter Expert (PE) queries the user about his reference method, sets up a Test Program, and walks the user through a series of tests to determine the highest acceptable test temperature. To speed development, tests are stopped if it looks like they will not end in a reasonable time, and a higher test temperature is tried instead. After development, PE programs the Test Program into the instrument. PE works on most samples, and typical PE development time is less than 2 hours for products with less than 25% moisture.

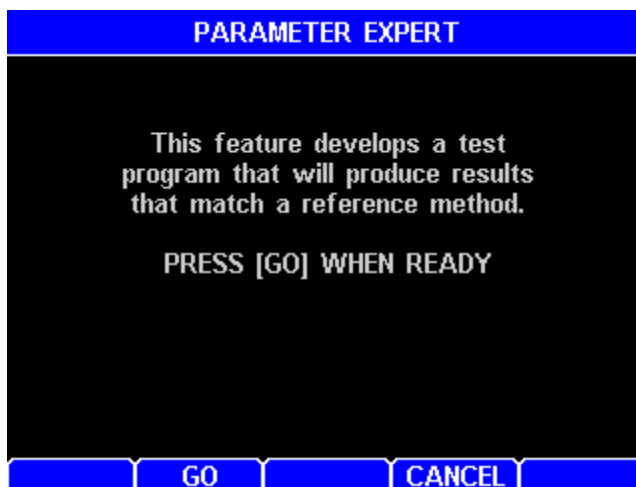

PE can be exited and reentered, and PE remembers the previous tests, so development can be continued where it was previously stopped.

The tests performed so far can be viewed in the TEST RESULTS list. The PE tests are prefixed with ^{PE}; the PE tests are likely of no benefit to the user after the Test Program has been developed and can be deleted if desired.

TEST RESULTS			
			1/158
1.	^{PE} LACTOSE	10-Oct-2007	5.300
2.	^{PE} LACTOSE	10-Oct-2007	5.300
3.	^{PE} LACTOSE	10-Oct-2007	5.300
4.	^{PE} LACTOSE	10-Oct-2007	5.300
5.	^{PE} LACTOSE	10-Oct-2007	5.300
6.	^{PE} LACTOSE	10-Oct-2007	5.300
7.	^{PE} LACTOSE	10-Oct-2007	1.792
8.	BLACK POLY P	10-Oct-2007	0.0223
9.	BLACK POLY P	10-Oct-2007	0.0238
10.	BLACK POLY P	10-Oct-2007	0.0244

DELETE ANALYZE SEL ALL VIEW PRINT

The Parameter Expert is user friendly and guides the user through the steps. The first step queries about the reference method:

- NAME – This is used for the new Test Program name. If an existing Test Program with the same name already exists, then PE will query if it should overwrite the existing Test Program.
- REF METHOD TEMP – Enter the temperature used by the reference method.
- APPLICATION – Enter the application type.
 - o Chemical
 - o Chemical-Pharmaceutical
 - o Food
 - o Plastic
- RESULT TYPE – Enter the result type output: % Moisture, % Solids, or % Dry Weight.
- TARGET RESULT – Enter the reference method result.
- FILTER PAPER – Liquids and creams may require filter paper to produce repeatable results. Try developing with **No** filter paper first.

PARAMETER EXPERT

NAME: LACTOSE

REF METHOD TEMP: 100 °C
 APPLICATION: Food
 RESULT TYPE: % Moisture
 TARGET RESULT: 5.3000
 FILTER PAPER: No

GO CANCEL

Next, PE will guide the user through a series of steps to develop the optimum test parameters, as shown below and on the following pages:

- First, ensure you have the material properly prepared.

PARAMETER EXPERT

Use a waffle pan.
 The test material must be homogenous. Grind/shred material that is > 1mm in diameter or has a skin.

PRESS [GO] WHEN READY

GO CANCEL

- Next, PE explains the process: Multiple tests are run at various temperatures to find an optimum ending criteria. At lower temperatures, the tests are slower. If it looks like the test will not end in a reasonable time, the test is stopped, and a higher temperature is used on the next test. At higher temperatures, the tests are faster.



- At the end of every test, you must determine if the sample burned or degraded. Generally, burned or degraded samples produce wrong and erratic results, so the temperature must be lowered on the next test.

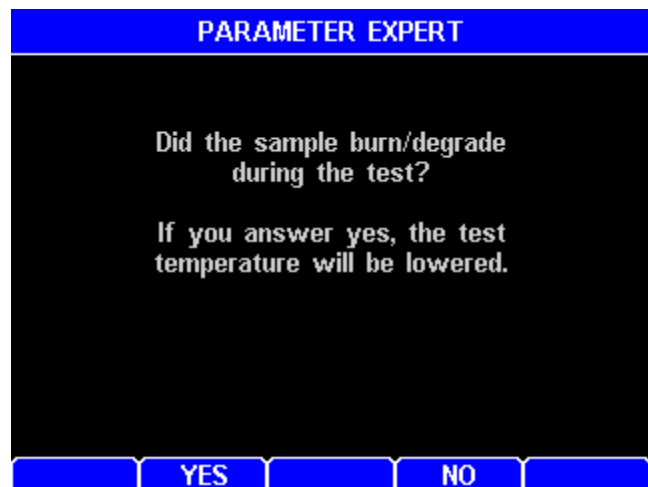

- PE continues to have the user run tests at various temperatures until the optimum ending criteria is found.

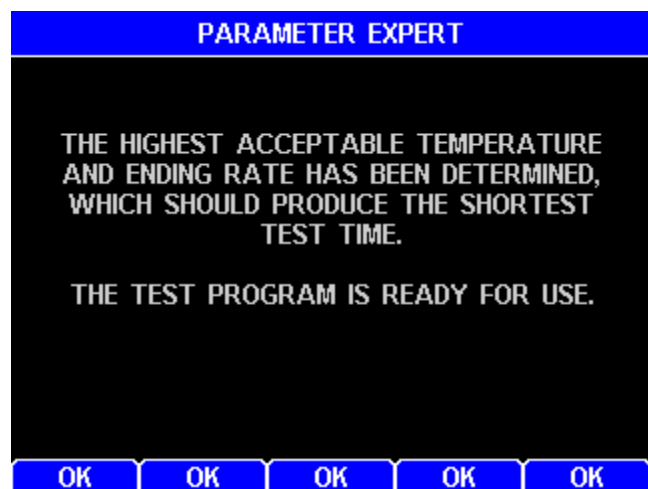

Once the Test Program has been developed, exit the Parameter Expert and run 5 tests to determine if the accuracy, speed, and repeatability are acceptable. Use the Optimize feature to make minor improvements (See section **8.6.2 Optimize Existing Test Program** on page **82**).

8.6.2 Optimize Existing Test Program

To get here, navigate:

[MENU]→PARAMETER EXPERT MENU→
OPTIMIZE EXISTING TEST PROGRAM

Parameter Expert (PE) can optimize an existing Test Program by allowing the user to slightly change the test temperature while PE determines the proper ending criteria. A higher test temperature improves test speed while a lower test temperature improves test repeatability.

The current selected Test Program will be optimized. If this is not the desired Test Program, exit PE and select the proper Test Program from the Test Program menu and then return to PE.

PE queries information on the current sample:

- TARGET RESULT – Enter the reference method result.
- NEW TEMP – Enter a new desired temperature or keep it the same to readjust the current ending criteria.

PARAMETER EXPERT

This feature allows the user to slightly change the current test program temp. Typically a higher temp results in a faster and less repeatable test. A lower temp results in a slower and more repeatable test. Only change the temp a few degrees at a time.

PRESS [GO] WHEN READY

GO CANCEL

PARAMETER EXPERT

NAME: LACTOSE

TARGET RESULT: 5.3000
RESULT TYPE: % Moisture
CURRENT TEMP: 154 °C
NEW TEMP: 155 °C

GO CANCEL

PE is ready to perform a single test to determine the proper rate ending criteria.



After running the single test, optimization is complete, and the Test Program is automatically updated and ready for use.

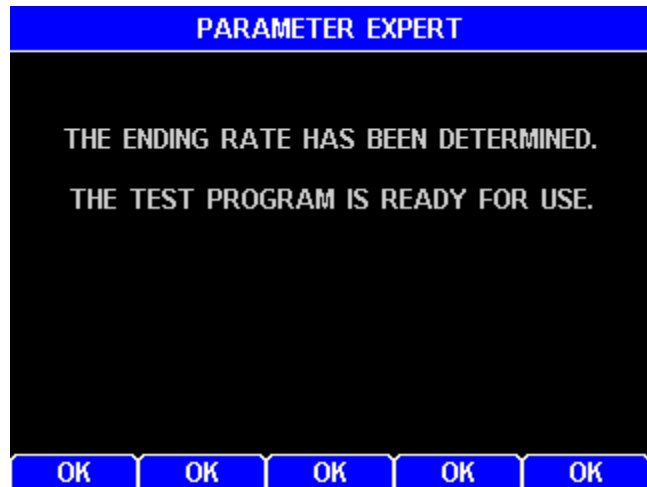

8.7. Sample Foils

To get here, navigate:
[MENU]→SAMPLE FOILS

This begins the process of weighing and storing foil weights up to a maximum of 50 unique foils. The foils are weighed before the sample is applied. After weighing, the foils are used in paint processes where the paint is sprayed onto the foil as the end product is being painted. When placed into the MAX[®] 4000, the foil weight is subtracted from both the start weight and end weight so that only the spray product will be considered in the moisture determination.

To use the foils for testing, SPECIAL TARE (in the Test Program) must be set to Foil (See section **8.1.5 Tare Options** on page 47).

Adding new foils:

- Press **[ADD]**. The first foil in the list is the last one added (LIFO). Note: The cooling fan must be off before weighing foils for the list, and there is no confirmation prompt before deleting a foil.

SAMPLE FOILS		
		1/7
1. TEST	08-Jun-2005	0.2447
2. F	12-May-2005	0.1494
3. E	12-May-2005	0.1574
4. D	12-May-2005	0.1456
5. C	12-May-2005	0.1465
6. B	12-May-2005	0.1440
7. A	12-May-2005	0.1532

ADD DELETE

- Follow the prompts to open the lid, place a foil on the sample pan, and close the lid.

SAMPLE FOIL WEIGH	
OPEN THE LID	OFF
LOAD SAMPLE FOIL	
0.0026g	26
	

ABORT

- After the foil is weighed and the lid is opened, the weight of the foil is given.
- Press **[ENT]** to begin editing, then enter the identifying NAME for this foil. Duplicate names are allowed. When done editing, press **[ENT]** again.
- Press **[SAVE]** to save the foil or **[CANCEL]** to return to the SAMPLE FOILS list.

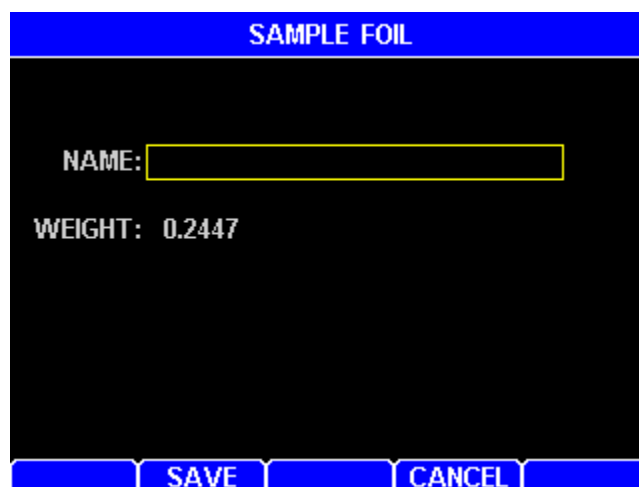

8.8. Audit Log

Available on the MAX[®] 4000XL only

To get here, navigate:
[MENU]→AUDIT LOG

The AUDIT LOG shows a history of instrument events. The following events are logged:

- Power on
- Calibrations
- Test Program Additions or Deletions
- Test Program Changes
- Test Result Deletions
- System Errors



Some errors, such as memory errors, cannot be logged, as a memory error may prevent the error data from being stored in memory. Generally, hardware errors are immediately displayed on the top line of the screen in red, and the instrument halts, so access to the Audit Log may not be possible. There are a few hardware errors, such as RTC Battery Failure, that may be displayed in a message box on the Test Done screen.

The Audit Log will maintain up to 1,000 entries before the oldest entries are deleted to record new entries.

On 21 CFR, Part 11 compliant instruments, the **[DELETE]** function is not available.

9. WEB SERVER

Optional and available on the MAX[®] 4000XL only

An optional Web Server can be purchased for the MAX[®] 4000XL, which allows the instrument to be accessed from your local area network (LAN) or intranet by a Windows[®] PC with Internet Explorer[®] (IE) version 6 or higher or Edge browser.

The Web Server provides the following functions:

- View the instrument LCD screen.
- View and print or save a combined balance and temperature calibration report.
- Save (download) instrument Test Programs to a local PC, or transfer (upload) them from a PC to instrument(s).
- View and save Test Result and graph data as spreadsheet compatible comma-separated values (.csv) files.
- View the Audit Log.

Prior to accessing the instrument with IE, the Ethernet settings must be configured (See section **8.4.4 Ethernet Setup** on page **72**). To access the instrument with IE, type the MAX[®] 4000XL's IP address into the IE address bar (192.168.2.251 for example), omitting any leading zeroes in any of the four address triplets, e.g., use 2, not 002, as shown in the example address above. The IP address is the one that you have configured (if using Manual mode) or is the one that was assigned by the DHCP server (if using Automatic mode).

For more information regarding the Web Server option, please contact your technical salesperson or Customer Service.

9.1. Calibration Report

The calibration report is viewed by selecting CALIBRATION REPORT in the left bar. This report is a combination of the balance and temperature calibration reports. The report can be downloaded to the PC as an HTML file.

BROOKFIELD AMETEK MAX 4000XL PREFERRED CUSTOMER SN: 4002200

CALIBRATION REPORT

LCD VIEW
TEST PROGRAMS
TEST RESULTS
AUDIT LOG

MAX 4000XL CALIBRATION REPORT

COMPANY NAME: PREFERRED CUSTOMER
INSTRUMENT #: 4002200
FORCE BALANCE #: 9830

FACTORY CAL DUE: 06-Jun-2020

BALANCE CALIBRATION

SPAN CALIBRATION: 05-Jun-2019
WEIGHT: 19.9996g Pass

LINEARITY VERIFICATION: 05-Jun-2019
WEIGHT KIT SN: P802
WEIGHT KIT CERT DATE: 21-Feb-2019

LINEARITY VERIFICATION RESULTS:

TOTAL	MEASURED	WEIGHT
10.0g	9.9995g	9.9995g Pass
20.0g	19.9998g	10.0004g Pass
30.0g	29.9999g	10.0001g Pass
40.0g	40.0000g	10.0001g Pass
MEAN:		10.0000g

TEMPERATURE CALIBRATION

LAST CALIBRATION: 31-May-2019
LAST VERIFICATION: 31-May-2019

CAL MODULE #:
CAL PROBE #:
MODULE CERT DATE: 00-Err-0000

VERIFICATION RESULTS:

INSTRUMENT	TCI	DIFFERENCE
49.9°C	49.1°C	0.8°C Pass
74.9°C	74.3°C	0.6°C Pass
100.1°C	99.3°C	0.8°C Pass

Print / Save

Copyright 2019 AMETEK Brookfield

9.2. LCD View

Selecting LCD VIEW in the left bar allows remote monitoring of the instrument.

The screenshot shows a web browser window displaying the LCD View interface for a Brookfield AMETEK MAX 4000XL instrument. The browser address bar shows the URL 10.100.5.78/. The interface features a blue header with the Brookfield AMETEK logo, the instrument model MAX 4000XL, the status 'PREFERRED CUSTOMER', and the serial number SN: 4002200. A left sidebar contains navigation options: CALIBRATION REPORT, LCD VIEW (selected), TEST PROGRAMS, TEST RESULTS, and AUDIT LOG. The main display area shows a green LCD screen with the following information: Date: 04-Oct-2019, Time: 08:01:56, TESTED: WEIGHT, 37.495 % Moisture, [PASS], TIME: 1:07, TO TEST WEIGHT - PRESS START, TEST PROGRAMS - PRESS PROGRAM, and a weight reading of 0.0009g. A red vertical bar on the right side of the LCD screen indicates a moisture level between 80 and 89. At the bottom of the LCD screen are four buttons: CONTRAST, PROGRAM, MENU, and GRAPH. The footer of the browser window displays 'Copyright 2019 AMETEK Brookfield'.

9.3. Test Programs

Test Programs are viewed by selecting TEST PROGRAMS in the left bar. Test Programs can be downloaded from the instrument to the PC or can be uploaded to the instrument from the PC. Thus, Test Programs can be retrieved from one MAX[®] 4000XL instrument and saved to another.

Typically, set up one MAX[®] 4000XL with the desired Test Programs, transfer the Test Programs to the PC, and then transfer the Test Programs from the PC to other MAX[®] 4000XL instruments. Test Programs are saved in a comma-separated format on the PC and can be read by Microsoft Excel[®], though attempting to edit the Test Programs in Excel[®] is not recommended.

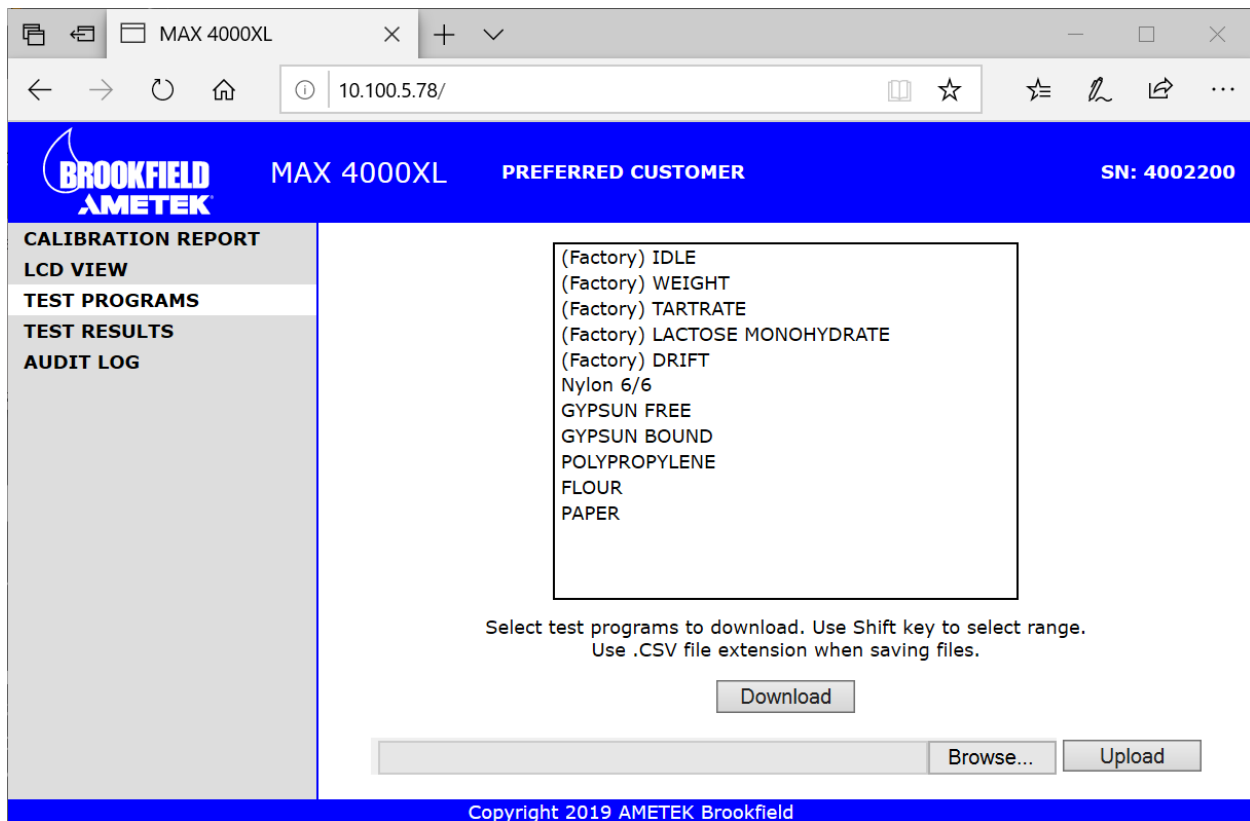

The screenshot shows a web browser window with the URL 10.100.5.78/. The page header includes the Brookfield AMETEK logo, the text "MAX 4000XL", "PREFERRED CUSTOMER", and "SN: 4002200". The left sidebar contains navigation links: "CALIBRATION REPORT", "LCD VIEW", "TEST PROGRAMS", "TEST RESULTS", and "AUDIT LOG". The main content area displays a list of test programs: "(Factory) IDLE", "(Factory) WEIGHT", "(Factory) TARTRATE", "(Factory) LACTOSE MONOHYDRATE", "(Factory) DRIFT", "Nylon 6/6", "GYPSUN FREE", "GYPSUN BOUND", "POLYPROPYLENE", "FLOUR", and "PAPER". Below the list, there is a "Download" button and instructions: "Select test programs to download. Use Shift key to select range. Use .CSV file extension when saving files." At the bottom of the interface, there are "Browse..." and "Upload" buttons. The footer of the page reads "Copyright 2019 AMETEK Brookfield".

9.4. Test Results

Test Results can be viewed by selecting TEST RESULTS in the left bar. Test Results cannot be modified or deleted through the Web Server; data can only be deleted at the instrument.

Test Results are saved in a comma-separated format, which can be read by Microsoft Excel®. The “Report Items to Print” (See section **8.4.2.B Report Items to Print** on page 71) controls which items are included in the report.

Graph data contains only the data points that are used by the instrument to generate the graph, so the actual visual graph is not downloaded.

The screenshot shows a web browser window with the URL 10.100.5.78/. The page header includes the Brookfield AMETEK logo, the instrument model MAX 4000XL, the status 'PREFERRED CUSTOMER', and the serial number SN: 4002200. A left-hand navigation menu lists 'CALIBRATION REPORT', 'LCD VIEW', 'TEST PROGRAMS', 'TEST RESULTS' (which is selected), and 'AUDIT LOG'. The main content area displays a table of test results with columns for the test name, date, and value. The first row, 'WEIGHT', is highlighted in green with a value of 37.495. Below the table, there is a selection instruction: 'Select test results to download. Use Shift key to select range. Use .CSV file extension when saving files.' Two buttons are present: 'Download Tests' and 'Download Test & Graph Data'. The footer of the page reads 'Copyright 2019 AMETEK Brookfield'.

Test Name	Date	Value
WEIGHT	04-Oct-2019	37.495
Nylon 6/6	13-Nov-2017	0.1296
Nylon 6/6	13-Nov-2017	0.1160
Nylon 6/6	13-Nov-2017	0.1240
Nylon 6/6	13-Nov-2017	0.1181
Nylon 6/6	13-Nov-2017	0.1279
GYP SUM BOUND	08-Nov-2017	20.2816
GYP SUM FREE	08-Nov-2017	-0.0190
GYP SUM BOUND	08-Nov-2017	20.2753
GYP SUM FREE	08-Nov-2017	-0.0161
GYP SUM BOUND	08-Nov-2017	20.2734
GYP SUM FREE	08-Nov-2017	-0.0270
GYP SUM BOUND	08-Nov-2017	20.2944
GYP SUM FREE	08-Nov-2017	-0.0191
GYP SUM BOUND	08-Nov-2017	20.2882
GYP SUM FREE	08-Nov-2017	-0.0280
LACTOSE MONOHYDRATE	07-Nov-2017	5.060

9.5. Audit Log

Available on the MAX[®] 4000XL only.

The Audit Log is viewed by selecting AUDIT LOG in the left bar. The log can be downloaded to the PC as an HTML file. See section **8.8 Audit Log** on page **85** for more details on the Audit Log.

The screenshot shows a web browser window with the URL 10.100.5.78/. The page header includes the Brookfield AMETEK logo, the device name MAX 4000XL, the status PREFERRED CUSTOMER, and the serial number SN: 4002200. The left sidebar contains a menu with options: CALIBRATION REPORT, LCD VIEW, TEST PROGRAMS, TEST RESULTS, and AUDIT LOG (which is selected). The main content area displays the MAX 4000XL AUDIT LOG with a list of power-on events. A 'Print / Save' button is located at the bottom of the log area. The footer of the page reads 'Copyright 2019 AMETEK Brookfield'.

MAX 4000XL AUDIT LOG		
04-Oct-2019 07:56:21	Power on	
03-Oct-2019 15:21:07	Power on	
03-Oct-2019 13:57:46	Power on	
02-Oct-2019 15:07:21	Power on	
02-Oct-2019 15:05:02	Power on	
02-Oct-2019 14:47:46	Power on	
01-Oct-2019 15:16:03	Power on	
12-Aug-2019 13:51:53	Power on	
12-Aug-2019 12:59:40	Power on	
17-Jul-2019 10:02:14	Power on	
16-Jul-2019 09:21:47	Power on	
01-Jul-2019 08:43:12	Power on	
26-Jun-2019 08:25:52	Power on	
26-Jun-2019 08:24:33	Power on	
26-Jun-2019 08:07:44	Power on	
21-Jun-2019 14:05:49	Power on	
17-Jun-2019 15:45:17	Power on	

10. PERFORMANCE VERIFICATION

Periodic checks of the system are recommended to verify proper system operation. These periodic checks will satisfy some quality assurance requirements as specified in your quality assurance/control policy. A log is recommended, either handwritten or computer managed, which will record the weight test results, sodium tartrate test results, and retained samples' results. Shifts in results that are out of range can be quickly detected and the appropriate corrections made.

10.1. The Weight Test

The weight test simulates moisture loss with the removal of one of two known weights, using the (Factory) WEIGHT Test Program.

This test may be used:

- At the interval established by your quality assurance/control program.
- Any time the instrument is moved, the power switched off, the instrument is jarred or bumped.
- If there is any concern about the accuracy of the instrument.
- To become familiar with the instrument.

See section **7.1 Performing a Test** on page **35** to perform the weight test. Both a 3g and a 5g weight are required. Test Results should fall between 37.480% and 37.520%. The final test result screen indicates Pass or Fail by a Green or Red background respectively and a PASS or FAIL after the result. The TEST RESULTS list also indicates Pass or Fail by using Green or Red text respectively for the result. For greatest precision, ensure that the chamber temperature has reached 80 °C before performing weight tests. If the WEIGHT test fails, repeat the balance calibration and weight test. If the WEIGHT test still fails, call Customer Service for assistance.

If desired, perform the weight test multiple times to determine the instrument's repeatability; this is a more critical verification of the instrument's performance. For greatest precision, ensure that the chamber temperature has reached 80 °C before performing weight tests. Perform five tests and then compute the mean, standard deviation, and relative standard deviation. (For data analysis instructions, see section **8.2 Test Results** on page **54**).

10.2. Sodium Tartrate Test

The (Factory) TARTRATE test verifies the heater and force balance operation. Sodium tartrate dihydrate is a chemical with a known moisture content that releases moisture at temperatures greater than 120 °C.

Because of its consistent moisture content, sodium tartrate is used as a standard in moisture measurement using oven or titration methods. To obtain consistently reliable results, use a high quality or reagent grade (ACS certified) granular sodium tartrate. Sift the sodium tartrate through a #20 sieve to obtain a more uniform size and produce better results. Lumps in sodium tartrate usually indicate moisture absorption that will yield inconsistent results. Discard the larger chunks, or pestle them through the sieve and return them to the bottle.

Sodium tartrate (P/N: 800-0037) is available from AMETEK Brookfield's consumable parts sales.

See section **7.1 Performing a Test** on page **35** and select (Factory) TARTRATE as the Test Program to perform the TARTRATE test. The Test Program is factory configured to use approximately 8 grams of sample and run at 150 °C. Test Results should be within a range of ± 0.1 of the assayed value on the label of the chemical.

Discard the first test result of the day for stability reasons.

If desired, perform the sodium tartrate test multiple times to determine the instrument's repeatability. This is a more critical verification of the instrument's performance. Perform five tests and then compute the mean, standard deviation, and relative standard deviation (See section **8.2 Test Results** on page **54**).

If the results are out of tolerance, then:

- Check for bent or dirty sample pans; use new/clean sample pans for each test.
- Carefully clean the chamber interior (See section **11.1 Heat Chamber** on page **94**).
- Check the balance shaft for debris (See section **11.2 Balance Shaft Check** on page **95**).
- Clean the heater and check the temperature sensor (See section **11.3 Heater Cleaning** on page **95**).
- If a Temperature Calibration Kit is available, temperature calibrate the system (See section **8.3.2 Temperature Calibration** on page **62**).

After performing the above suggestions, repeat the sodium tartrate test again, and analyze the results. If the results are still out of tolerance, call Customer Service for assistance.

10.3. Retained Samples

The weight test and the sodium tartrate test are usually sufficient to satisfy industry guidelines for quality control in moisture measurement. Some additional checks can be performed using replicate testing of retained samples. Retained samples, when stored under airtight conditions, should maintain moisture levels for long periods. Routine testing of these samples should produce the same results day after day. Retained samples further verify the instrument's operation on the customer's own product. If hygroscopic materials are used, the values can change with time and repeated opening of the sample storage container.

Perform tests using the Test Program for the retained sample (See section 7.1 **Performing a Test** on page 35). Results should fall within the established acceptable range of results for that sample. If results are out of range, repeat the test to verify results and/or perform standard reference testing to certify the percent moisture value.

11. ROUTINE MAINTENANCE

The MAX[®] 4000 requires routine cleaning to keep the test chamber free of excess sample material. Failure to keep the instrument interior clean reduces its accuracy and repeatability, as sample material collecting in the test chamber prevents free movement of the pan support. In addition, sample material collecting on the rim of the heater shroud prevents the lid from closing completely, causing erratic results. Excess material may also fall into the system's interior, causing balance problems. Routine cleaning of the test chamber reduces the likelihood of problems and repairs, extending the life of the instrument.

11.1. Heat Chamber Cleaning

The chamber interior should be cleaned when needed to eliminate the buildup of sample material. To clean debris from the chamber's interior:

- Use a small paintbrush to remove debris from the balance cover and surrounding area. Be gentle around the pan support to prevent balance damage.
- If using a vacuum line or small vacuum cleaner, be careful not to hit the pan support. **Do not clean the balance cover area with a vacuum line or vacuum cleaner without turning the instrument off and removing the pan support first to avoid balance damage.** It is recommended to only use a paintbrush on the balance cover area; then a vacuum can be used to clean the surrounding area.



A compressed air line or canned air is not recommended because debris may be forced into the system's interior, balance shaft and balance, and may damage the instrument resulting in costly repairs.



11.2. Balance Shaft Check

Perform the following:

- Clean the heat chamber before performing this check (See section **11.1 Heat Chamber** on page **94**). This keeps debris from falling into the balance shaft.
- Turn the instrument off.
- Use the supplied tweezers to remove the pan support; place the tweezers' tips under the pan support and pry the pan support straight up and out of the balance stem. **Be careful; excess force on the balance can result in costly repairs.**
- Remove the balance cover.
- Look down the balance shaft to the balance and make sure that the area is free of debris.
- Reinstall the balance cover.
- Gently but firmly install the pan support into the balance stem.

11.3. Heater Cleaning



Perform a heater cleaning only if a Temperature Calibration Kit is available. If not, contact Customer Service to arrange for the instrument's return to the factory for cleaning and calibration.



An oven cleaner such as "Easy-Off" should not be used on the aluminum shroud as it is corrosive and will remove the coating and pit the aluminum.



Cleaning frequency will vary depending on the application and frequency of use. We recommend that you establish a periodic cleaning schedule to ensure instrument-to-instrument correlation and performance. Call Customer Service if you have any questions.

Testing of some materials may cause a brown discoloration behind the heater and on the inside of the heater shroud. This darkening affects results as heat is absorbed rather than reflected from the heater shroud onto the sample. However, the "browned" condition may be allowed to remain on the heater shroud and heater box if test results can be maintained within an acceptable range.

Cleaning procedure:

- The following cleaning materials are needed:
 - Cleaning solution, such as Formula 409[®], in a spray bottle.
 - Cloth and/or paper towels
 - Small stiff bristle brush, such as a toothbrush or acid brush
 - Cotton swabs or cotton tipped applicators
 - Water for cleaning and wiping shroud and heater after cleaning
 - Small Phillips head screwdriver (if you elect to remove the shroud)
- Turn the instrument off
- Remove the power cord.
- Wait for the instrument to cool down to room temperature.

- Use the supplied tweezers to remove the pan support; place the tweezers' tips under the pan support and pry the pan support straight up and out of the balance stem. **Be careful; excess force on the balance can result in costly repairs.**
- Cover the pan support hole in the enclosure with masking or other similar tape.
- Carefully mark the RTD with a permanent marker on the inside and outside of the shroud and clamp to mark the relative RTD position in the heater.
- Remove the shroud to provide the maximum cleaning benefit.
 - Remove the four (4) evenly spaced, small screws, located on the outside of the shroud.
 - Carefully slide the RTD out of the shroud. Take care not to pull the RTD wires out of the heater box while removing the shroud.
- Lightly spray the shroud with cleaning solution and allow it to stand for several minutes. Scrub with the stiff bristle brush. Repeat if necessary to remove layers of accumulated buildup. Rinse under warm water and dry.
- Before cleaning the rest of the test chamber, protect the heater elements by placing paper towels around the elements.
- Next, lightly spray the front (face) of the heater box and allow it to stand, or alternately spray a damp cloth or paper towel with cleaner and use it to clean the heater box. Use a small brush or cotton swab to remove excess buildup. Dry the interior of the test chamber with paper towels or a cloth when clean.



Do NOT use a heavy spray of cleaner into the heater and/or shroud area. Excessive moisture could affect wiring and its insulation.



- Allow the heater elements and enclosure to dry for at least 15 minutes to ensure that they are completely dry.
- Reinstall the heater shroud and correctly position the RTD using the marks made with the permanent marker.
- Remove the masking tape from the pan support hole in the enclosure.
- Gently but firmly install the pan support into the balance stem.
- Run a weight test to verify that the instrument is functioning correctly (See section **10.1 The Weight Test** on page **92**).
- Perform a temperature calibration. (See **8.3.2 Temperature Calibration** on page **62**).

11.4. Pan Support Cleaning

The sample pan support may need to be cleaned if volatile material condenses on it.

- Turn the instrument off.
- Use the supplied tweezers to remove the pan support; place the tweezers' tips under the pan support and pry the pan support straight up and out of the balance stem. **Be careful; excess force on the balance can result in costly repairs.**
- Clean the support post and pan support arms by wiping with a soft cloth or paper towel.
- Gently but firmly install the pan support into the balance stem.
- Ensure the arms of the pan support are all level and between 1.9mm and 3mm from the balance cover. See section **6.2 Interior of Test Chamber** on page **16** for inspection instructions.

11.5. Lithium Battery Replacement

If the clock fails to keep time when the instrument is turned off, the battery on the main control board is likely depleted. The battery is not user replaceable. Contact Customer Service for further details and information.

12. INSTRUMENT PROBLEMS & ERROR MESSAGES

SYMPTOM	DIAGNOSIS	REMEDY
Blank display or very hard to see	Contrast controls not set	Adjust contrast. See section 6.5 Contrast Adjustment on page 19 .
	No power	Check "No power to instrument" symptom.
	Software error	Turn instrument off and back on or call Customer Service for assistance
	Hardware failure	Call Customer Service for assistance
Display erratic	Instrument cold (near freezing)	Allow to warm-up
Heat will not turn off	Hardware failure	Call Customer Service for assistance
No graphical display	Graphics not selected	Press [GRAPH] key at Main Test screen
No heat	Voltage selection wrong	Check power module at rear of instrument, set to correct voltage. See section 6.3 AC Power Connection on page 16 .
	Wiring failure in heater circuit	Call Customer Service for assistance
	Heater failure	Call Customer Service for assistance
	Door sensor failure	Check for heat symbol during a test or elevated idle temperature. If inactive, then door sensor is bad. Call Customer Service for assistance
No power to instrument	Power switch off	Check switch position, confirm power cord seating, remove and test fuse. See section 6.3 AC Power Connection on page 16 .
	Power cord disconnected	
	Fuse blown	
	Outlet not powered	Test the outlet with a lamp or meter.
No weight reading	Balance not initialized	Turn power off, wait 5 seconds, turn power on, and wait 15 seconds. Call Customer Service for assistance.
Balance reports UNDER	Pan support not in place	Install pan support.

SYMPTOM	DIAGNOSIS	REMEDY
SYSTEM ERROR: _____	System software error	Cycle power to instrument, then call Customer Service for assistance.
Instrument will not tare	Test chamber temperature fluctuates/changes	Allow system to stabilize.
	Dirt in heat chamber or under pan support	Clean instrument. See section 11.1 Heat Chamber on page 94 .
	Debris in balance shaft	See section 11.2 Balance Shaft Check on page 95 .
Heater Watchdog Timing Problem	Possible hung internal process	Cycle power to instrument. If this message recurs, call Customer Service for assistance.
Balance Failure	Balance failure	Call Customer Service for assistance.
RTC Battery Failure	Internal battery failure	Call Customer Service for assistance.
RS232_Configure failed	Internal instrument operating system error	Cycle power to instrument. If this message recurs, call Customer Service for assistance.

13. TEST RESULT PROBLEMS

SYMPTOM	DIAGNOSIS	REMEDY
Final results vary too much	Test temperature incorrect	Determine new temperature/ending criteria to use or Use Parameter Expert to develop a new Test Program on the MAX [®] 4000XL or Call Customer Service for assistance
	Ending criteria incorrect	
	Sample size too small	Increase sample size. See section 8.1.4 Sample Size Options on page 46 .
	Samples not uniform	Grind sample.
	Sample particles too large	See section 7.2 Preparing Granular and Powdery Samples on page 38 .
Moisture result too high or solids result too low	Temperature set too high	Decrease temperature. See section 8.1.2 Temperatures on page 43 or call Customer Service for assistance.
	Bent sample pan	Use new pan
	Dirty sample pan	Use new pan
	Debris in balance	Call Customer Service for assistance
	Lift compensation too low	Increase the lift compensation percentage. See section 8.1.7 Lift Compensation on page 52 .
	Dirty heater assembly	Clean heater assembly. See section 11.3 Heater Cleaning on page 95 .
	Ending criteria incorrect	Determine new ending criteria. See section 8.1.3 Ending Criteria on page 45 or call Customer Service for assistance.
Moisture result too low or solids result too high	Temperature too low	Increase temperature. See section 8.1.2 Temperatures on page 43 or call Customer Service for assistance.
	Sample size too small or too large	Adjust sample size. See section 8.1.4 Sample Size Options on page 46 .
	Sample needs spreading	Spread sample evenly. See section 7.1 Performing a Test on page 35 .
	Lift compensation too high	Decrease the lift compensation percentage. See section 8.1.7 Lift Compensation on page 52 .
	Ending criteria incorrect	Determine new ending criteria. See section 8.1.3 Ending Criteria on page 45 or call Customer Service for assistance.

SYMPTOM	DIAGNOSIS	REMEDY
Moisture never stops increasing	Other volatiles	Decrease temperature. See section 8.1.2 Temperatures on page 43 or call Customer Service for assistance.
	Balance drifting	Call Customer Service for assistance
Erratic results	Poor AC ground	Ensure instrument is grounded from case ground to earth ground. Call Customer Service for assistance.
	Dirt in chamber	Clean instrument. See section 11.1 Heat Chamber on page 94 and section 11.3 Heater Cleaning on page 95 .
	Dirt or grime on pan support	See section 11.4 Pan Support on page 96 .
Test ends prematurely and the result is 0% moisture.	Possibly unstable balance.	Watch the weight displayed on the main screen when instrument is idle. If it appears to be unstable or fluctuating greatly, call Customer Service for assistance.
	Pan support is too low and possibly touching balance cover gasket.	Remove pan support from instrument. Adjust position of set screw between top of pan support & pan support stem by spinning top of pan support counterclockwise while holding stem to prevent rotation.
Test of low moisture sample ends prematurely and the result is 0% moisture.	Ultra-Low Moisture sample tare is not being used.	Use Ultra Low Moisture sample tare setting. See section 8.1.5 Tare Options on page 47 .
	Test temperature too low to evolve moisture from sample	Try a higher test temperature.
	Adequate moisture for detection is not being evolved	Try a larger sample size. However, if the sample size is too large, the interior of the sample may be shielded from the heater, preventing moisture evolution.

14. APPENDIX A: SAVING & LOADING TEST PROGRAMS

To save a copy of any or all of the Test Programs to a USB drive.

- Insert the USB drive in the corresponding port of the MAX[®] 4000 and confirm that the USB drive icon has appeared in the lower left corner of the instrument's screen.
- Press **[MENU]**, then highlight and use **[ENT]** to select 1.TEST PROGRAMS.
- If the **[SAVE]**, **[LOAD]**, **[PRINT]**, and **[MOVE]** soft keys are not displayed, press **[I/O]** to display them.
- Press **[SAVE]**. An on-screen prompt will communicate that the Test Programs will be saved to a file named **TESTPGM.CSV** that is stored on the USB drive.
- Press **[GO]**. The Test Programs listing will be displayed.
- Use the up and down arrows to move to each of the Test Programs that you would like to copy and press **[ENT]** on the keypad. A yellow pointer will mark each Test Program selected.
- Press **[GO]**. The instrument will indicate that Test Programs are being copied and then confirm success or else indicate that a USB drive was not found.
- The USB drive now contains a .CSV file with all of the selected Test Programs. This .CSV file can now be emailed, shared, and copied to other USB drives to ensure that all instruments are using the same Test Programs.

**NOTE: Modifying the Test Programs while they are on the USB drive, although possible, is not recommended. Modification can cause the file to become unable to be uploaded or read by the instrument.*

To load a copy of all of your Test Programs from a USB drive to a MAX[®] 4000/XL.

**The MAX[®] 4000 model only has 6 user Test Programs; make sure to delete enough Test Programs from the instrument so there is enough space to load the entire list of programs in the file on the USB drive. Otherwise, the Test Programs will not be loaded successfully.*

- Insert the USB drive with the **TESTPGM.CSV** file in the corresponding port of the MAX[®] 4000 and note that the USB drive icon has appeared in the lower left corner of the instrument's screen.
- Press **[MENU]**, then highlight and use **[ENT]** to select 1.TEST PROGRAMS.
- If the **[SAVE]**, **[LOAD]**, **[PRINT]**, and **[MOVE]** soft keys are not displayed, press **[I/O]** to display them.
- Press **[LOAD]**. An on-screen prompt will communicate that the Test Programs will be loaded from a file named TESTPGM.CSV that is stored on the USB drive.
- Press **[GO]**. The Test Programs listing will be displayed.
- Press the up and down arrows to move to the position in the Test Programs list below which the Test Programs should be loaded.
- Press **[GO]**. The instrument will indicate that the Test Programs are being loaded and then confirm success or else indicate that a USB drive was not found.
- All of the Test Programs from the USB drive are now available on the MAX[®] 4000/XL.

15. MAX[®] 4000 SPECIFICATIONS

FEATURE	SPECIFICATION
Size	9.5" height x 11.5" width x 19.5" depth 240 mm height x 300 mm width x 495 mm depth
Weight	32 lbs. (14.5 kg)
Power Requirements	100-120 VAC, 50/60 Hz @ 8A, 0.2A Heat Off 220-240 VAC, 50/60 Hz @ 4A, 0.1A Heat Off
Operating Environment	0-40 °C @ 50% humidity; 0-30 °C @ 80% humidity Non-condensing, non-explosive
Heating Range	25 °C to 225 °C on the MAX [®] 4000 25 °C to 275 °C on the MAX [®] 4000XL
Sample size	100mg to 40g (0.2 ± 0.1g to 39.9 ± 0.1g)
Balance Resolution	MAX [®] 4000: 0.001g MAX [®] 4000XL: 0.0001g
Moisture Resolution	MAX [®] 4000: 0.01% Moisture (fixed at two decimal digits) MAX [®] 4000XL: 0.001% Moisture (Default) or programmable from 0.0 to 0.00000
Repeatability	0.002% standard deviation depending upon Test Program.
Moisture Range	MAX [®] 4000: 0.1% to 99.9% Moisture MAX [®] 4000XL: 0.005% to 100% Moisture
Dry Weight Range	0% to 300%
Heater Calibration (MAX [®] 4000XL only)	Menu driven. NIST Traceable using an accessory Temperature Calibration Kit with a 1.5 °C precision. Calibration points every 25 °C from 50 °C to 275 °C. Verification points at every calibration point or up to four user-programmable verification points. Programmable calibration reminder.
Temperature Control	±1 °C of setpoint
Test Temperatures	User programmable idle temperature, test temperature, high start temperature, and temperature ramp rate. Multiple test temperatures are programmable through linked test sequences. (MAX [®] 4000XL only)
Test Display	Moisture, solids, or dry weight Custom result calculations and optional secondary custom result calculation in addition to primary calculation. (MAX [®] 4000XL only) Current and programmed chamber temperature. Elapsed test time. Sample name. Rate of weight loss. Linked test results for multistage test. (MAX [®] 4000XL only)
Ending Criteria	MAX [®] 4000: Prediction, Rate →Rate can be set as low as 0.01%/minute MAX [®] 4000XL: Prediction, Rate, Time, Time or Rate, Temp→Predict, Temp→Rate, Temp→Time or Rate →Rate can be set as low as 0.0010%/minute

FEATURE	SPECIFICATION
Parameter Expert (MAX [®] 4000XL only)	Assists user to develop Test Program parameters to match a reference method.
Balance	Integrated balance with automatic operation. Balance capacity of 40g. Standalone balance mode available when not testing samples. Resistant to nominal vibration with options available for isolation feet.
Balance Span Calibration	Menu driven calibration and verification by the end user. Programmable calibration reminder.
Balance Linearity Verification	2 to 8 points at either a 0.5, 1, 2, 3, 5, and 10g increment and up to 40g total. (MAX [®] 4000XL only)
User Interface	Menu driven user programmable interface through keypad and large color display.
Display	¼ VGA, 320 x 240-pixel color with adjustable contrast via contrast screen
Electronic Interface	USB host for USB printer, keyboard or USB drive connection. Serial port for PC connection and Temperature Calibration Interface (TCI) module connection. Ethernet for Web Server (Optional, MAX [®] 4000XL only) USB connector for computer connection.
Web Server (Optional) (MAX [®] 4000XL only)	Web Server used with Microsoft Internet Explorer [®] allows a user to: <ul style="list-style-type: none"> • Download a complete calibration report. • View the LCD screen • Download and upload Test Programs. • Download Test Results and Test Graph data. • View and download the Audit Log
Memory	Storage for: MAX [®] 4000:10 Test Programs (6 user programs and 4 factory), 2 Test Results and no Test Graphs. MAX [®] 4000XL: 250 Test Programs (245 user and 5 factory), 1,000 Test Results with the last 100 Test Graphs
Statistical Calculation	Mean, standard deviation, relative standard deviation
21 CFR, Part 11 compliant instruments	The Delete Test Results and Delete Audit Log functions are disabled.
User Login	Up to 20 users can be configured with username and passkey <ul style="list-style-type: none"> • When active, a user must be logged in before a test can be run (MAX[®] 4000XL only). • Standard user: Can perform tests, view data and reports. • Configuration user: Can also change setup configuration, add/edit/delete Test Programs, and delete data. • Calibration user: Can also perform balance and temperature calibrations.
Self-diagnostics	Built in hardware and software diagnostics software
Lid Fan	Rapidly cools the heat chamber to reduce time between tests to increase overall throughput.

FEATURE	SPECIFICATION
Options	Temperature calibration interface kit (MAX [®] 4000XL only) Printer kit IQ/OQ/PQ Validation Package (MAX [®] 4000XL only) Web Server (MAX [®] 4000XL only) External Filter Kit Nitrogen Purge Kit and Nitrogen Control module Bar Code Reader
Calibration Weights	Factory calibration weights, ASTM Class 1 Field calibration and test weights, NIST Class F or ASTM Class 5
Warranty	Domestic U.S. - 2 years factory parts and labor International - 1 year
Certifications	UL CE

16. WARRANTY

AMETEK Brookfield warrants the Computrac[®] MAX[®] 4000 to be free from defects in materials or workmanship for two (2) years from the date of purchase for those instruments sold in the USA. All other sales normally carry a one (1) year warranty. AMETEK Brookfield will repair or replace, at its option, products that AMETEK Brookfield determines to be defective during the warranty period. All defective parts replaced by AMETEK Brookfield become the property of AMETEK Brookfield. Replacement parts are warranted for the remaining portion of the effective warranty period. This warranty does not apply to expendable or maintenance items such as pans.

The above warranty does not extend to any product which has been subjected to misuse, abuse, neglect, accident, improper application, modifications or service performed by persons other than AMETEK Brookfield's own service representatives; power surges or spikes; negligence in use, maintenance, storage, transportation or handling; or acts of God.

If a MAX[®] product is defective in workmanship or materials, the owner's sole remedy shall be repair or replacement of the defective part, or parts, as provided above. Under no circumstances shall AMETEK Brookfield be liable in any way to the owner or any user for any damage including, but not limited to, any loss of business or profits or any other direct, indirect, special incidental, or consequential damages, whether or not foreseeable, and whether or not based on breach of warranty, contract, or negligence in connection with the sale of such products. (Some states do not allow the exclusion or limitation of incidental or consequential damages, so the above limitations or exclusions may not apply to you.)

No other warranty is expressed or implied including the warranties of merchantability or fitness for a particular purpose. In no event shall AMETEK Brookfield be liable for consequential and/or incidental damages.

The effective warranty begins on the date of purchase by, or lease to, the first end-user (owner). Keep the dated bill of sale, or invoice, for evidence of the effective warranty date when warranty service is requested.

In the event that any questions or problems should arise in the use or application of your Computrac[®] MAX[®] 4000 instrument, call Customer Service or your technical sales representative.

TRADEMARK AND COPYRIGHT PROTECTION

Computrac[®], MAX[®], AMETEK[®] Brookfield and the stylized AMETEK[®] Brookfield logo are all registered trademarks.

Instrument firmware is copyright protected.

All specifications subject to change without notice.

The MAX[®] 4000 uses the Graphics Interchange Format[®] as part of its Ethernet interface. The Graphics Interchange Format is the Copyright property of CompuServe Incorporated. GIF(sm) is a Service Mark property of CompuServe Incorporated.

Windows[®], Excel[®], Internet Explorer[®] and Microsoft Edge are registered trademarks of Microsoft Corporation in the United States and other countries.

Formula 409[®] is a registered trademark of The Clorox Company.

Copyright 2008-2021 AMETEK Brookfield. All Rights Reserved.

AMETEK Brookfield

Computrac[®] MAX[®] 4000 / MAX[®] 4000XL Moisture Analyzer

Part Number: 700-0111

Revision: 3.0

If you have any questions regarding the operation of this instrument, please call or e-mail for assistance.

AMETEK Brookfield
3375 N Delaware Street
Chandler, AZ 85225 USA
(800) 528-7411
(602) 470-1414
Fax (602) 281-1745

www.brookfieldengineering.com

Email:

sales.computrac@ametek.com - Sales

international.computrac@ametek.com - International

customerservice.computrac@ametek.com - Customer Support